



ODVODNI SISTEM POLUOKRUGLI



**CJENIK
2024**



POWERFUL PARTNER FOR YOUR ROOF



Pocink
materijal | 3



Žlijeb | 6



Dilatacija
žlijeba | 14



Žlijeb
oprema | 17



Kuka | 21



Kutnik | 26



Čelo
žlijeba | 28



Kotlić | 30



Koljeno | 44



Odvodna
cijev | 49



Odvodna cijev
oprema | 58



Obujmica | 61

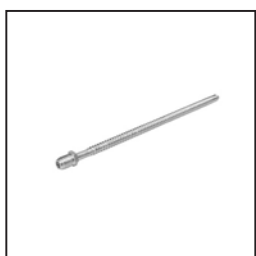

Obujmica
oprema | 65



Zadržać
vode | 68



Zaštitna
cijev | 71

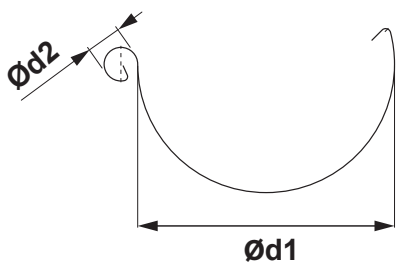

DIMENZIJE KROVNIH ŽLJEBOVA

(dimenzije i mjerne tolerancije po EN 612)

Razvijena širina (mm)	200	250	280	333	400	500
Ød1	80	105	127	153	192	250
Ød2	16	18	18	20	22	22

UNUTARNJI FALZ

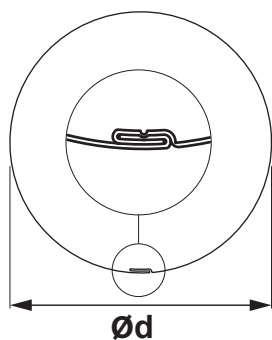

DIMENZIJE KROVNIH CIJEVI

(dimenzije i mjerne tolerancije po EN 612)

Dimenzije	60	80	100	120	150
Nazivna veličina Ød (mm)	60	80	100	120	150

DIMENZIJE KROVNIH KUKA

(dimenzije i mjerne tolerancije po EN 612)

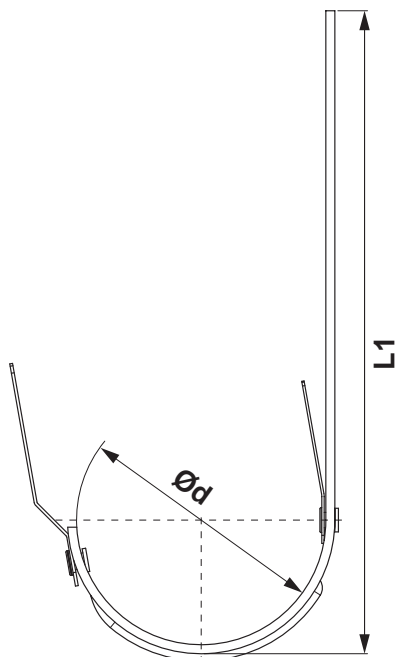

Dimenzije (mm)	L1	Ød
200	290	80
250	310	105
280	345	127
333 – 550	385	153
333 – 610	445	153
400	400	192

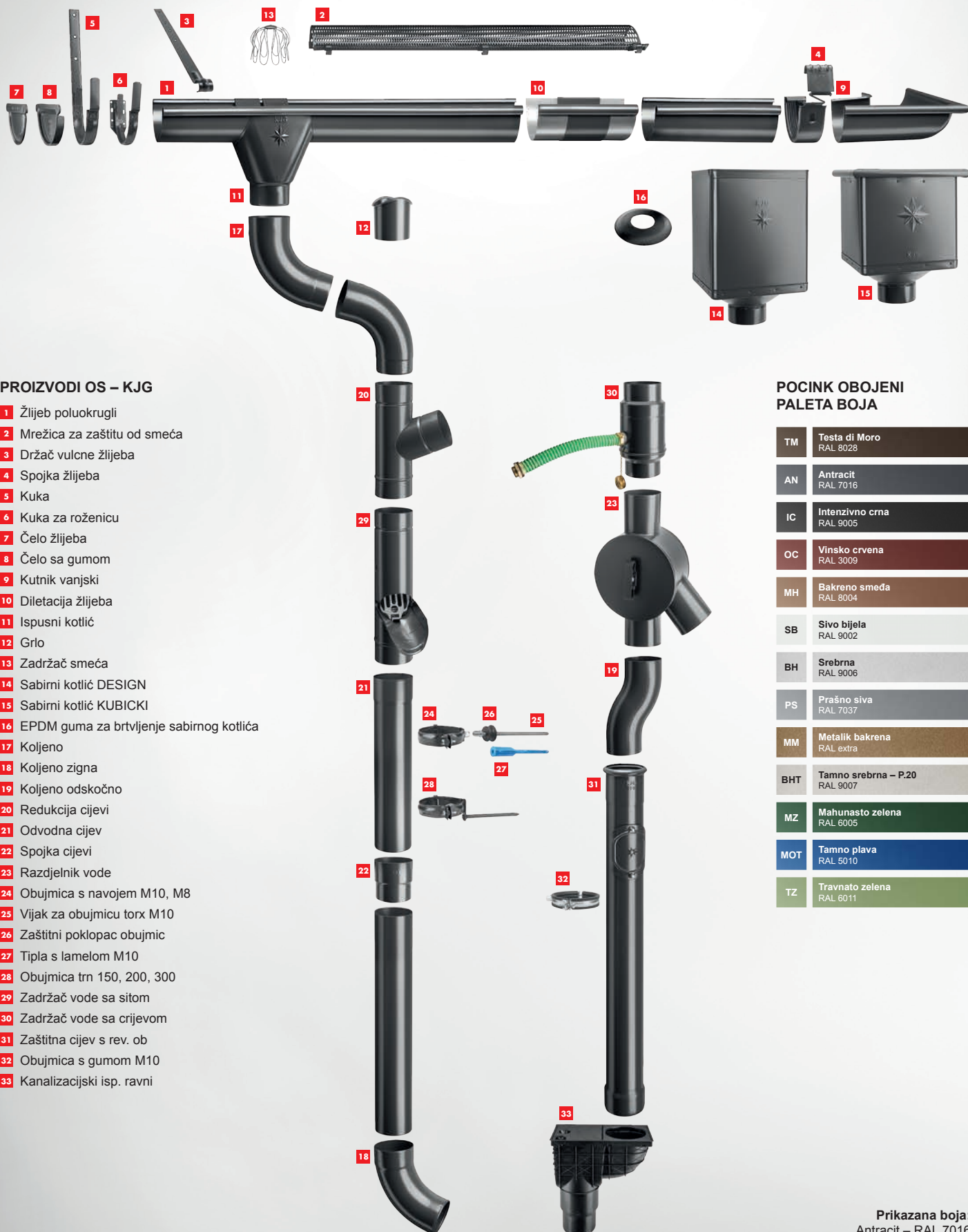

PROIZVODI OS – KJG

- 1 Žlijeb poluokrugli
- 2 Mrežica za zaštitu od smeća
- 3 Držač vulcne žlijeba
- 4 Spojka žlijeba
- 5 Kuka
- 6 Kuka za roženicu
- 7 Čelo žlijeba
- 8 Čelo sa gumom
- 9 Kutnik vanjski
- 10 Diletacija žlijeba
- 11 Ispusni kotlić
- 12 Grllo
- 13 Zadržlač smeća
- 14 Sabirni kotlić DESIGN
- 15 Sabirni kotlić KUBICKI
- 16 EPDM guma za brtvljenje sabirnog kotlića
- 17 Koljeno
- 18 Koljeno zigna
- 19 Koljeno odskočno
- 20 Redukcija cijevi
- 21 Odvodna cijev
- 22 Spojka cijevi
- 23 Razdjelnik vode
- 24 Obujmica s navojem M10, M8
- 25 Vijak za obujmicu torx M10
- 26 Zaštitni poklopac obujmic
- 27 Tipla s lamelom M10
- 28 Obujmica trn 150, 200, 300
- 29 Zadržlač vode sa sitom
- 30 Zadržlač vode sa crijevom
- 31 Zaštitna cijev s rev. ob
- 32 Obujmica s gumom M10
- 33 Kanalizacijski isp. ravni

**POCINK OBOJENI
PALETA BOJA**

TM	Testa di Moro RAL 8028
AN	Antracit RAL 7016
IC	Intenzivno crna RAL 9005
OC	Vinsko crvena RAL 3009
MH	Bakreno smeđa RAL 8004
SB	Sivo bijela RAL 9002
BH	Srebrna RAL 9006
PS	Prašno siva RAL 7037
MM	Metalik bakrena RAL extra
BHT	Tamno srebrna – P.20 RAL 9007
MZ	Mahunasto zelena RAL 6005
MOT	Tamno plava RAL 5010
TZ	Travnato zelena RAL 6011

TATA STEEL





Tvrka Tata osnovana je 1868. godine društvom Jamsetji Nusserwanji Tata sa sjedištem u Indiji. Tata je globalni poslovni konglomerat koji djeluje u više od 100 zemalja na pet kontinenta. Od kada je stupila na tržište čelika i automobila, drži korak s najnovijim tehnologijama, grupa Tata ima jaku poziciju u raznim ograncima industrije, kao što su agrokemikalije, automobilska industrija, kemikalije, građevinarstvo, financije, potrošački proizvodi i ugostiteljstvo.

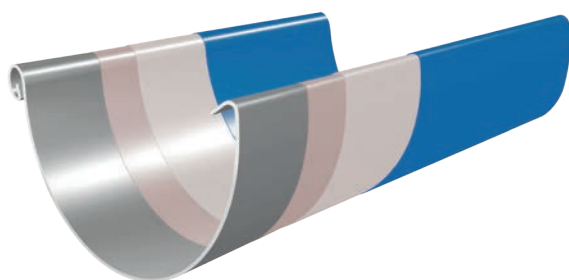

MARCEGAGLIA

Marcegaglia vodeći je igrač u Italiji, te najveća nezavisna globalna firma u čeličnoj industriji. Svake godine obradi 5,6 milijuna tona, ima promet viši od 5 milijardi eura (2017). Time je Marcegaglia, talijanska industrijska grupa, jedna od vodećih kompanija na području čelične industrije u Europi i cijelom svijetu. Njeno vodstvo rezultat je duga, čvrsta i stabilna rasta, koji je od Marcegaglia napravio ovog najvećeg nezavisnog globalnog igrača u obradi čelika.



-  Gornji sloj je lak (cca. 20 μm) na bazi poliestera za odličan izgled i izvrsnu otpornost na ogrebotine
-  Primer (cca. 5 μm) za savršeno prijanjanje i snažnu zaštitu od korozije
-  Sloj cinka (225 g/m²) za trajnu zaštitu od korozije
-  Čelični lim optimiziran za proizvodnju odvodnog sistema OS – KJG

ŽLIJEB POLUOKRUGLI [s=0,55]

P-PZ

Nominalna veličina	200		200		200	
Dužina u m	2,0		3,0		4,0	
Cijena u €/m	Bez PDV	S PDV	Bez PDV	S PDV	Bez PDV	S PDV
TM 1 Testa di Moro RAL 8028	6,95	8,69	6,95	8,69	6,95	8,69
	043610		043627		043634	
AN 2 Antracit RAL 7016	6,95	8,69	6,95	8,69	6,95	8,69
	042187		042194		042200	
IC 3 Intenzivno crna RAL 9005	6,95	8,69	6,95	8,69	6,95	8,69
	042545		042552		042569	
OC 4 Vinsko crvena RAL 3009			6,95	8,69	6,95	8,69
			043191		043207	
MH 5 Bakreno smeđa RAL 8004			7,05	8,81		
			042750			
SB 6 Sivo bijela RAL 9002			7,05	8,81		
			043498			
BH 7 Srebrna RAL 9006			7,05	8,81	7,05	8,81
			042392		042408	
PS 8 Prašno siva RAL 7037			7,05	8,81	7,05	8,81
			043375		043382	
MM 9 Metalik bakrena RAL extra			7,50	9,38		
			042927			
BHT – P.20 10 Tamno srebrna RAL 9007						
MZ 11 Mahunasto zelena RAL 6005			7,50	9,38		
			043085			
MOT 12 Tamno plava RAL 5010			7,50	9,38		
			043016 *			
TZ 13 Travnato zelena RAL 6011			7,50	9,38		
			043825 *			
Pak. u m 	10		15		20	
Pak. u m 	800		1 200		1 600	

* Proizvodnja po narudžbi

POCINK
POLYESTER



ŽLIJEB POLUOKRUGLI [s=0,55]

P-PZ

Nominalna veličina	250		250		250		250		250		
Dužina u m	2,0		3,0		4,0		5,0		6,0		
Cijena u €/m	Bez PDV	S PDV	Bez PDV	S PDV	Bez PDV	S PDV	Bez PDV	S PDV	Bez PDV	S PDV	
TM Testa di Moro RAL 8028	1	6,20	7,75	6,05	7,56	6,05	7,56	6,05	7,56	6,05	7,56
		043641		043658		043665		043672		043689	
AN Antracit RAL 7016	2	6,20	7,75	6,05	7,56	6,05	7,56	6,05	7,56	6,05	7,56
		042217		042224		042231		042248		042255	
IC Intenzivno crna RAL 9005	3	6,20	7,75	6,05	7,56	6,05	7,56	6,05	7,56	6,05	7,56
		042576		042583		042590		042606		042613	
OC Vinsko crvena RAL 3009	4	6,20	7,75	6,05	7,56	6,05	7,56	6,05	7,56	6,05	7,56
		043214		043221		043238		043245		043252	
MH Bakreno smeđa RAL 8004	5	6,30	7,88	6,15	7,69	6,15	7,69	6,15	7,69	6,15	7,69
		042774		042781		042798		042804		042811	
SB Sivo bijela RAL 9002	6			6,15	7,69	6,15	7,69			6,15	7,69
				043504		043511				043528	
BH Srebrna RAL 9006	7			6,15	7,69	6,15	7,69	6,15	7,69	6,15	7,69
				042415		042422		042439		042446	
PS Prašno siva RAL 7037	8					6,15	7,69			6,15	7,69
						043399				043405	
MM Metalik bakrena RAL extra	9					6,50	8,13			6,50	8,13
						042934				042941	
BHT – P.20 Tamno srebrna RAL 9007	10					7,50	9,38				
						095466					
MZ Mahunasto zelena RAL 6005	11					6,50	8,13			6,50	8,13
						043092				043108	
MOT Tamno plava RAL 5010	12					6,50	8,13				
						043023					
TZ Travnato zelena RAL 6011	13					6,50	8,13				
						043832					
Pak. u m 		10		15		20		25		30	
Pak. u m 		480		720		960		1 200		1 440	



ŽLIJEB POLUOKRUGLI [s=0,55]

P-PZ

Nominalna veličina	280		280		280		280		280	
Dužina u m	2,0		3,0		4,0		5,0		6,0	
Cijena u €/m	Bez PDV	S PDV	Bez PDV	S PDV	Bez PDV	S PDV	Bez PDV	S PDV	Bez PDV	S PDV
TM 1 Testa di Moro RAL 8028	7,00	8,75	6,85	8,56	6,85	8,56	6,85	8,56	6,85	8,56
	043696		043702		043719		043726		043733	
AN 2 Antracit RAL 7016	7,00	8,75	6,85	8,56	6,85	8,56	6,85	8,56	6,85	8,56
	042262		042279		042286		042293		042309	
IC 3 Intenzivno crna RAL 9005	7,00	8,75	6,85	8,56	6,85	8,56	6,85	8,56	6,85	8,56
	042620		042637		042644		042651		042668	
OC 4 Vinsko crvena RAL 3009			6,85	8,56	6,85	8,56	6,85	8,56	6,85	8,56
			043269		043276		043283		043290	
MH 5 Bakreno smeđa RAL 8004			6,95	8,69	6,95	8,69			6,95	8,69
			042828		042835				042842	
SB 6 Sivo bijela RAL 9002					6,95	8,69			6,95	8,69
					043535				043542	
BH 7 Srebrna RAL 9006			6,95	8,69	6,95	8,69			6,95	8,69
			042453		042460				042477	
PS 8 Prašno siva RAL 7037					6,95	8,69			6,95	8,69
					043412				043429	
MM 9 Metalik bakrena RAL extra					7,45	9,31			7,45	9,31
					042958				042965	
BHT – P.20 10 Tamno srebrna RAL 9007					8,40	10,50				
					095473					
MZ 11 Mahunasto zelena RAL 6005					7,45	9,31			7,45	9,31
					043115				043122	
MOT 12 Tamno plava RAL 5010					7,45	9,31				
					043030					
TZ 13 Travnato zelena RAL 6011					7,45	9,31				
					043849					
Pak. u m 📦	10		15		20		25		30	
Pak. u m 🚚	420		630		840		1 050		1 260	

POCINK
POLYESTER



ŽLIJEB POLUOKRUGLI [s=0,55]



P-PZ

Nominalna veličina	333		333		333		333		333	
Dužina u m	2,0		3,0		4,0		5,0		6,0	
Cijena u €/m	Bez PDV	S PDV	Bez PDV	S PDV	Bez PDV	S PDV	Bez PDV	S PDV	Bez PDV	S PDV
TM Testa di Moro RAL 8028	7,30	9,13	7,10	8,88	7,10	8,88	7,10	8,88	7,10	8,88
	043740		043757		043764		043771		043788	
AN Antracit RAL 7016	7,30	9,13	7,10	8,88	7,10	8,88	7,10	8,88	7,10	8,88
	042316		042323		042330		042347		042354	
IC Intenzivno crna RAL 9005	7,30	9,13	7,10	8,88	7,10	8,88	7,10	8,88	7,10	8,88
	042675		042682		042699		042705		042712	
OC Vinsko crvena RAL 3009	7,30	9,13	7,10	8,88	7,10	8,88	7,10	8,88	7,10	8,88
	043306		043313		043320		043337		043344	
MH Bakreno smeđa RAL 8004	7,40	9,25	7,20	9,00	7,20	9,00	7,20	9,00	7,20	9,00
	042859		042866		042873		042880		042897	
SB Sivo bijela RAL 9002			7,20	9,00	7,20	9,00	7,20	9,00	7,20	9,00
			043559		043566		043573		043580	
BH Srebrna RAL 9006			7,20	9,00	7,20	9,00	7,20	9,00	7,20	9,00
			042484		042491		042507		042514	
PS Prašno siva RAL 7037			7,20	9,00	7,20	9,00	7,20	9,00	7,20	9,00
			043436		043443		043450		043467	
MM Metalik bakrena RAL extra					8,30	10,38	8,30	10,38	8,30	10,38
					042972		042989		042996	
BHT – P.20 Tamno srebrna RAL 9007					8,50	10,63			8,50	10,63
					095480				095497	
MZ Mahunasto zelena RAL 6005					8,30	10,38	8,30	10,38	8,30	10,38
					043139		043146		043153	
MOT Tamno plava RAL 5010					8,30	10,38			8,30	10,38
					043047				043054	
TZ Travnato zelena RAL 6011					8,30	10,38				
					043856					
Pak. u m 	10		15		20		25		30	
Pak. u m 	330		495		660		825		990	



ŽLIJEB POLUOKRUGLI [s=0,55]

P-PZ

Nominalna veličina	400		400		500		500		333		
Dužina u m	4,0		6,0		4,0		6,0		7,0		
Cijena u €/m	Bez PDV	S PDV	Bez PDV	S PDV	Bez PDV	S PDV	Bez PDV	S PDV	Bez PDV	S PDV	
TM Testa di Moro RAL 8028	1	11,45	14,31	11,45	14,31					7,10	8,88
		043801		043818						043795 *	
AN Antracit RAL 7016	2	11,45	14,31	11,45	14,31	15,50	19,38	15,50	19,38		
		042361		042378		086730 *		086747 *			
IC Intenzivno crna RAL 9005	3	11,45	14,31	11,45	14,31						
		042729		042736							
OC Vinsko crvena RAL 3009	4	11,45	14,31	11,45	14,31						
		043351		043368							
MH Bakreno smeđa RAL 8004	5	11,55	14,44	11,55	14,44						
		042903		042910							
SB Sivo bijela RAL 9002	6	11,55	14,44	11,55	14,44	15,60	19,50	15,60	19,50		
		043597		043603		086778 *		086785 *			
BH Srebrna RAL 9006	7	11,55	14,44	11,55	14,44	15,60	19,50	15,60	19,50		
		042521		042538		086754 *		086761 *			
PS Prašno siva RAL 7037	8	11,55	14,44	11,55	14,44						
		043474		043481							
MM Metalik bakrena RAL extra	9	12,15	15,19								
		043009									
BHT – P.20 Tamno srebrna RAL 9007	10			12,80	16,00						
				095503							
MZ Mahunasto zelena RAL 6005	11	12,15	15,19	12,15	15,19						
		043160		043177 *							
MOT Tamno plava RAL 5010	12	12,15	15,19	12,15	15,19						
		043061		043078							
TZ Travnato zelena RAL 6011	13	12,15	15,19								
		043863 *									
Pak. u m 		20		30		20		30		35	
Pak. u m 		540		810		-		-		1 155	

* Proizvodnja po narudžbi

POCINK
POLYESTER



ŽLIJEB POLUOKRUGLI [s=0,50]

P-PZ

Nominalna veličina	250		250		250		250		250	
Dužina u m	2,0		3,0		4,0		5,0		6,0	
Cijena u €/m	Bez PDV	S PDV	Bez PDV	S PDV	Bez PDV	S PDV	Bez PDV	S PDV	Bez PDV	S PDV
TM Testa di Moro RAL 8028	5,30	6,63	5,30	6,63	5,30	6,63	5,30	6,63	5,30	6,63
	069184 *		069191		069207		069009 *		069214 *	
AN Antracit RAL 7016			5,30	6,63	5,30	6,63	5,30	6,63	5,30	6,63
			068729		068736		068743 *		068750 *	
IC Intenzivno crna RAL 9005			5,30	6,63	5,30	6,63	5,30	6,63	5,30	6,63
			068965		068972		068989 *		068996 *	
OC Vinsko crvena RAL 3009			5,30	6,63	5,30	6,63	5,30	6,63	5,30	6,63
			069108 *		069115		069122 *		069139 *	
BH Srebrna RAL 9006			5,30	6,63	5,30	6,63	5,30	6,63	5,30	6,63
			068842 *		068859		068866 *		068873 *	
TH Tamno smeđa ČOKO RAL 8017			5,30	6,63	5,30	6,63			5,30	6,63
			084774 *		084781				084804 *	
MH Bakreno smeđa RAL 8004			5,30	6,63	5,30	6,63	5,30	6,63	5,30	6,63
			084934 *		084941		084958 *		084965 *	
Pak. u m	10		15		20		25		30	
Pak. u m	480		720		960		1 200		1 440	

* Proizvodnja po narudžbi

ŽLIJEB POLUOKRUGLI [s=0,50]

P-PZ

Nominalna veličina	280		280		280		280	
Dužina u m	3,0		4,0		5,0		6,0	
Cijena u €/m	Bez PDV	S PDV	Bez PDV	S PDV	Bez PDV	S PDV	Bez PDV	S PDV
TM Testa di Moro RAL 8028	5,80	7,25	5,80	7,25	5,80	7,25	5,80	7,25
	069238 *		069245		069252 *		069269 *	
AN Antracit RAL 7016	5,80	7,25	5,80	7,25	5,80	7,25	5,80	7,25
	068767 *		068774		068781 *		068798 *	
IC Intenzivno crna RAL 9005	5,80	7,25	5,80	7,25	5,80	7,25	5,80	7,25
	069016 *		069023		069030 *		069047 *	
OC Vinsko crvena RAL 3009	5,80	7,25	5,80	7,25	5,80	7,25	5,80	7,25
	069054 *		084767		084811 *		084866 *	
BH Srebrna RAL 9006	5,80	7,25	5,80	7,25	5,80	7,25	5,80	7,25
	068880 *		068897		068903 *		068910 *	
TH Tamno smeđa ČOKO RAL 8017			5,80	7,25			5,80	7,25
			084835 *				084859 *	
MH Bakreno smeđa RAL 8004	5,80	7,25	5,80	7,25	5,80	7,25	5,80	7,25
	084989 *		084996		085009 *		085016 *	
Pak. u m	15		20		25		30	
Pak. u m	630		840		1 050		1 260	

* Proizvodnja po narudžbi

POCINK POLYESTER

ŽLIJEB POLUOKRUGLI [s=0,50]

P-PZ

Nominalna veličina	333		333		333	
Dužina u m	2,0		3,0		4,0	
Cijena u €/m	Bez PDV	S PDV	Bez PDV	S PDV	Bez PDV	S PDV
TM Testa di Moro RAL 8028	6,50	8,13	6,50	8,13	6,50	8,13
	069276 *		069283 *		069290	
AN Antracit RAL 7016			6,50	8,13	6,50	8,13
			068804 *		068811	
IC Intenzivno crna RAL 9005			6,50	8,13	6,50	8,13
			069061 *		069078	
OC Vinsko crvena RAL 3009			6,50	8,13	6,50	8,13
			069146 *		069153	
BH Srebrna RAL 9006			6,50	8,13	6,50	8,13
			068927 *		068934	
TH Tamno smeđa ČOKO RAL 8017			6,50	8,13	6,50	8,13
			084873 *		084880	
MH Bakreno smeđa RAL 8004			6,50	8,13	6,50	8,13
			085030 *		085047	
Pak. u m	10		15		20	
Pak. u m	330		495		660	

* Proizvodnja po narudžbi

ŽLIJEB POLUOKRUGLI [s=0,50]

P-PZ

Nominalna veličina	333		333		333	
Dužina u m	5,0		6,0		7,0	
Cijena u €/m	Bez PDV	S PDV	Bez PDV	S PDV	Bez PDV	S PDV
TM Testa di Moro RAL 8028	6,50	8,13	6,50	8,13	6,50	8,13
	069306 *		069313 *		069320 *	
AN Antracit RAL 7016	6,50	8,13	6,50	8,13		
	068828 *		068835 *			
IC Intenzivno crna RAL 9005	6,50	8,13	6,50	8,13		
	069085 *		069092 *			
OC Vinsko crvena RAL 3009	6,50	8,13	6,50	8,13		
	069160 *		069177 *			
BH Srebrna RAL 9006	6,50	8,13	6,50	8,13		
	068941 *		068958 *			
TH Tamno smeđa ČOKO RAL 8017	6,50	8,13	6,50	8,13		
	084897		084903			
MH Bakreno smeđa RAL 8004	6,50	8,13	6,50	8,13		
	085054 *		085061 *			
Pak. u m	25		30		35	
Pak. u m	825		990		1 155	

* Proizvodnja po narudžbi

ŽLIJEB NATKROVNI [s=0,55]

P-PZS

Nominalna veličina	650		650	
Dužina u m	4,0		6,0	
Cijena u €/m	Bez PDV	S PDV	Bez PDV	S PDV
TM 1 Testa di Moro RAL 8028	24,50	30,63	24,50	30,63
	049926		049933	
AN 2 Antracit RAL 7016	24,50	30,63	24,50	30,63
	049759		049766	
IC 3 Intenzivno crna RAL 9005	24,50	30,63	24,50	30,63
	049797		049803	
OC 4 Vinsko crvena RAL 3009	24,50	30,63	24,50	30,63
	049865		049872	
MH 5 Bakreno smeđa RAL 8004	25,50	31,88	25,50	31,88
	049810		049827	
SB 6 Sivo bijela RAL 9002	25,50	31,88		
	049902			
BH 7 Srebrna RAL 9006	25,50	31,88	25,50	31,88
	049773		049780	
PS 8 Prašno siva RAL 7037	25,50	31,88		
	049889			
MM 9 Metalik bakrena RAL extra	28,00	35,00		
	049834			
BHT – P.20 10 Tamno srebrna RAL 9007	32,50	40,63		
	095749 *			
MZ 11 Mahunasto zelena RAL 6005	28,00	35,00		
	049858			
MOT 12 Tamno plava RAL 5010	28,00	35,00		
	049841 *			
TZ 13 Travnato zelena RAL 6011	28,00	35,00		
	049940 *			
Pak. u m 	4		6	
Pak. u m 	200		300	

* Proizvodnja po narudžbi



DILETACIJA ŽLIJEBA

P-PZDI

Nominalna veličina	250/260		280/260		333/260		400/260	
	Bez PDV	S PDV	Bez PDV	S PDV	Bez PDV	S PDV	Bez PDV	S PDV
TM 1 Testa di Moro RAL 8028	14,60	18,25	15,50	19,38	16,90	21,13	19,90	24,88
	013064		013071		013088		013095	
AN 2 Antracit RAL 7016	14,60	18,25	15,50	19,38	16,90	21,13	19,90	24,88
	012661		012678		012685		012692	
IC 3 Intenzivno crna RAL 9005	14,60	18,25	15,50	19,38	16,90	21,13	19,90	24,88
	012746 *		012753 *		012760		012777 *	
OC 4 Vinsko crvena RAL 3009	14,60	18,25	15,50	19,38	16,90	21,13	19,90	24,88
	012944 *		012951 *		012968 *		012975 *	
MH 5 Bakreno smeđa RAL 8004	14,60	18,25	15,50	19,38	16,90	21,13	19,90	24,88
	012784 *		012791 *		012807 *		012814 *	
SB 6 Sivo bijela RAL 9002	14,60	18,25	15,50	19,38	16,90	21,13	19,90	24,88
	013026 *		013033 *		013040 *		013057 *	
BH 7 Srebrna RAL 9006	14,60	18,25	15,50	19,38	16,90	21,13	19,90	24,88
	012708 *		012715 *		012722 *		012739 *	
PS 8 Prašno siva RAL 7037	14,60	18,25	15,50	19,38	16,90	21,13	19,90	24,88
	012982 *		012999 *		013002 *		013019 *	
MM 9 Metalik bakrena RAL extra	14,60	18,25	15,50	19,38	16,90	21,13	19,90	24,88
	012821 *		012838 *		012845 *		012852 *	
BHT – P.20 10 Tamno srebrna RAL 9007	14,60	18,25	15,50	19,38	16,90	21,13	19,90	24,88
	096098 *		096104 *		096111 *		114044 *	
MZ 11 Mahunasto zelena RAL 6005	14,60	18,25	15,50	19,38	16,90	21,13	19,90	24,88
	012906 *		012913 *		012920 *		012937 *	
MOT 12 Tamno plava RAL 5010	14,60	18,25	15,50	19,38	16,90	21,13	19,90	24,88
	012869 *		012876 *		012883 *		012890 *	
TZ 13 Travnato zelena RAL 6011	14,60	18,25	15,50	19,38	16,90	21,13	19,90	24,88
	013101 *		013118 *		013125 *		013132 *	
Pak. u kom 	3		3		5		5	
Pak. u kom 	360		360		200		200	

* Proizvodnja po narudžbi

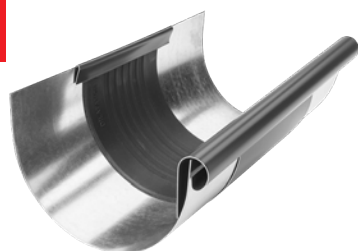

DILETACIJA ZA LEŽEĆI ŽLIJEB

P-PZSDI



Nominalna veličina	670/260	
Cijena u €/kom	Bez PDV	S PDV
TM 1 Testa di Moro RAL 8028	31,50	39,38
	013637 *	
AN 2 Antracit RAL 7016	31,50	39,38
	013545 *	
IC 3 Intenzivno crna RAL 9005	31,50	39,38
	013569 *	
OC 4 Vinsko crvena RAL 3009	31,50	39,38
	013606 *	
MH 5 Bakreno smeđa RAL 8004	31,50	39,38
	013576 *	
SB 6 Sivo bijela RAL 9002	31,50	39,38
	013620 *	
BH 7 Srebrna RAL 9006	31,50	39,38
	013552 *	
PS 8 Prašno siva RAL 7037	31,50	39,38
	013613 *	
MM 9 Metalik bakrena RAL extra	31,50	39,38
	013583 *	
BHT – P.20 10 Tamno srebrna RAL 9007	31,50	39,38
	096067 *	
MZ 11 Mahunasto zelena RAL 6005	31,50	39,38
	013651 *	
MOT 12 Tamno plava RAL 5010	31,50	39,38
	013590 *	
TZ 13 Travnato zelena RAL 6011	31,50	39,38
	013644 *	
Pak. u kom	1	
Pak. u kom	40	

* Proizvodnja po narudžbi

DILETACIJSKA TRAKA

P-PZDIP



Nominalna veličina	Dužina u m	EAN broj narudžbe	Pakiranje u m		Cijena [€/m]	
					Bez PDV	S PDV
260	3,0	012470	3	120	33,60	42,00
260	6,0	012487	6	240	33,60	42,00

KORIŠTENJE SPOJKE ŽLIJEBA I SPOJNE TRAKE

SPOJKA ŽLIJEBA

Primjer montaže: Podkorvni žlijeb razvijene širine do 500 mm. Spojka žlijeba mora biti montirana u međusobnoj udaljenosti 15 m. Za vanjski kutnik i početak žlijeba važi polovica standardne vrijednosti: maksimalno 7,5 m. Za unutarnji kutnik važi četvrtina standardne vrijednosti: maksimalno 3,75 m. Za ostale materijale i dimenzije: vidi tabelica dolje. Kutnici se uvijek smatraju čvrstim točkama.

KROVNI POLUOKRUGLI ŽLJEBOVI

Razvijena širina žlijeba	Aluminij	Pocink, Cinkotit, Bakar, Inox
< 500	12	15
> 500	8	10

SPAJANJE TRAKOM

Unutarnja instalacija: za četvrtaste žljebove pričvršćene za podlogu bez lijepljenja, za krovove s nestandardnim profilom, i oplatu zida limom

KROVNO SPAJANJE TRAKOM

Razvijena širina žlijeba	Aluminij	Pocink, Cinkotit, Bakar, Inox
< 500	8	10
> 500	6	8

Za vanjski kutnik ili početak žlijeba važi polovica standardne vrijednosti. Za unutarnji kutnik važi četvrtina standardne vrijednosti.

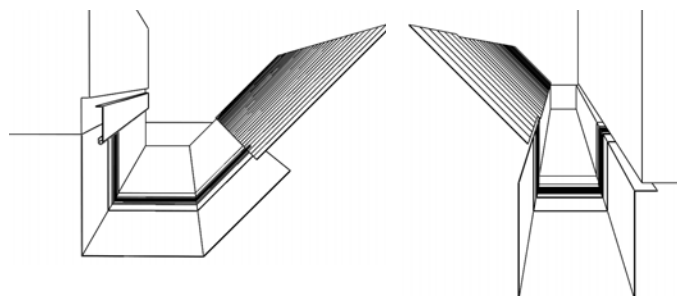
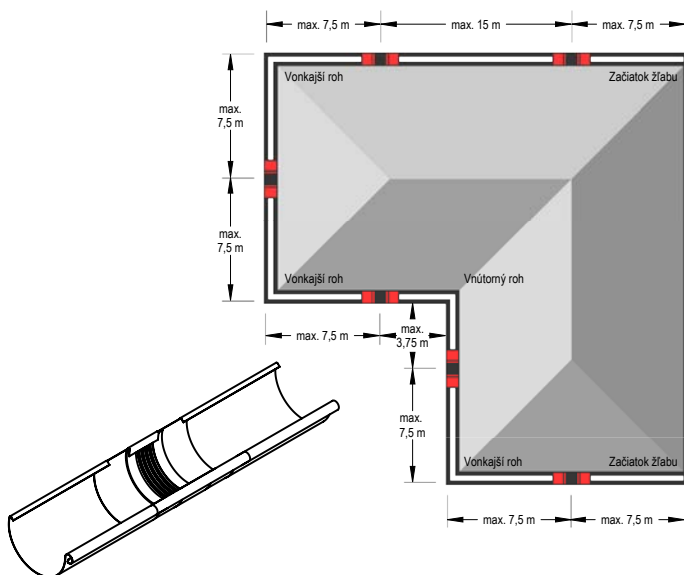

Napomena uz montažu spojne trake.

Kada se savija i montira spojna traka, provjerite sljedeće:

- Klijesta za savijanje imaju radijus minimalno 2 mm.
- Za debljinu lima 1 mm se mora održati polumjer savijanja minimalno 5 mm.
- Klijesta za savijanje moraju za vrijeme savijanja biti podešena za debljinu 3 do 4 mm, kako bi se spriječio efekt sječenja – oštećenja gume.
- Središnji gumeni dio za vrijeme savijanja ne smije biti pritisnut ili oštećen. Treba zbog toga koristiti aluminijsku limenu traku debljine 2 do 5 mm, i saviti je tako, da se može pričvrstiti kao zaštita za klijesta za savijanje. Time ćemo dobiti veći polumjer savijanja, i spriječiti da se ošteti središnji gumeni dio.

Napomena uz montažu spojne trake.

Za vrijeme montaže uz pomoć mekog lemljenja prvo pokrite dio mokrom krpom (kako ne bi došlo do prelaska topline u središnji gumeni dio). Mora se održavati minimalna udaljenost 6 cm od središnjeg gumenog dijela. U svakom slučaju treba izbjegavati kontakt gume s plamenom.

ALUMINIJSKA MREŽICA ZA ZAŠTITU OD SMEĆA

P-PZNLN

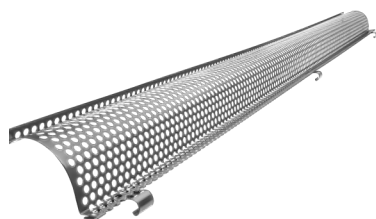





Nominalna veličina	333	
Dužina u m	2,0	
Cijena u €/kom	Bez PDV	S PDV
TM 1 Testa di Moro RAL 8028	26,50	33,13
	064943	
AN 2 Antracit RAL 7016	26,50	33,13
	064912	
IC 3 Intenzivno crna RAL 9005	26,50	33,13
	064929 *	
OC 4 Vinsko crvena RAL 3009	26,50	33,13
	064936 *	
MH 5 Bakreno smeđa RAL 8004	26,50	33,13
	119766 *	
SB 6 Sivo bijela RAL 9002	26,50	33,13
	117762 *	
BH 7 Srebrna RAL 9006	26,50	33,13
	117717 *	
PS 8 Prašno siva RAL 7037	26,50	33,13
	117755 *	
MM 9 Metalik bakrena RAL extra	26,50	33,13
	117724 *	
BHT – P.20 10 Tamno srebrna RAL 9007	26,50	33,13
	097156 *	
MZ 11 Mahunasto zelena RAL 6005	26,50	33,13
	117748 *	
MOT 12 Tamno plava RAL 5010	26,50	33,13
	117731 *	
TZ 13 Travnato zelena RAL 6011	26,50	33,13
	117779 *	
Pak. u kom	15	
Pak. u kom	120	

* Proizvodnja po narudžbi



PVC ŽLIJEJNI ZADRŽAČ SMEĆA

SD-ZNL MRIEZKA

Nominalna veličina	Dužina u m	EAN broj narudžbe	Pak. u kom		Cijena [€/kom]	
					Bez PDV	S PDV
 171	1,0	008473	30	450	4,50	5,63
 171	1,0	008466	30	450	4,50	5,63

PVC ŽLIJEJNI ZADRŽAČ SMEĆA

SD-ZNL N

Nominalna veličina	Dužina u m	EAN broj narudžbe	Pak. u kom		Cijena [€/kom]	
					Bez PDV	S PDV
250	3,0	008480	10	400	23,90	29,88
280-333	3,0	008497	10	400	24,00	30,00

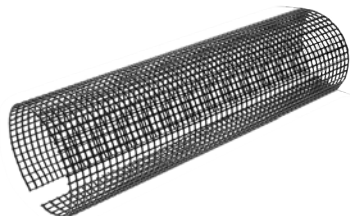
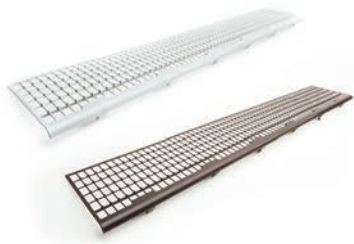

DRŽAČ VULCNE ŽLIJEBA

P-PDZNV



Nominalna veličina	250-280		333		400	
Rozmer v mm	18		20		22	
Cijena u €/kom	Bez PDV	S PDV	Bez PDV	S PDV	Bez PDV	S PDV
TM 1 Testa di Moro RAL 8028	1,60	2,00	1,60	2,00	1,60	2,00
	085665		085672		085689 *	
AN 2 Antracit RAL 7016	1,60	2,00	1,60	2,00	1,60	2,00
	085290		085306		085313	
IC 3 Intenzivno crna RAL 9005	1,60	2,00	1,60	2,00	1,60	2,00
	085351		085368		085375 *	
OC 4 Vinsko crvena RAL 3009	1,60	2,00	1,60	2,00	1,60	2,00
	085504		085573		085597 *	
MH 5 Bakreno smeđa RAL 8004	1,60	2,00	1,60	2,00	1,60	2,00
	085382		085399		085405 *	
SB 6 Sivo bijela RAL 9002	1,60	2,00	1,60	2,00	1,60	2,00
	085634 *		085641		085658 *	
BH 7 Srebrna RAL 9006	1,60	2,00	1,60	2,00	1,60	2,00
	085320		085337		085344 *	
PS 8 Prašno siva RAL 7037	1,60	2,00	1,60	2,00	1,60	2,00
	085603		085610		085627 *	
MM 9 Metalik bakrena RAL extra	1,60	2,00	1,60	2,00	1,60	2,00
	085412 *		085429		085436 *	
BHT – P.20 10 Tamno srebrna RAL 9007	1,60	2,00	1,60	2,00	1,60	2,00
	094636 *		094643 *		094650 *	
MZ 11 Mahunasto zelena RAL 6005	1,60	2,00	1,60	2,00	1,60	2,00
	085474 *		085481 *		085498 *	
MOT 12 Tamno plava RAL 5010	1,60	2,00	1,60	2,00	1,60	2,00
	085443 *		085450 *		085467 *	
TZ 13 Travnato zelena RAL 6011	1,60	2,00	1,60	2,00	1,60	2,00
	085696 *		085702 *		085719 *	
Pak. u kom 	25		25		25	
Pak. u kom 	3 000		3 000		3 000	

* Proizvodnja po narudžbi



SPOJKA ŽLIJEBA

P-PSPZ

Nominalna veličina	250		280		333	
	Bez PDV	S PDV	Bez PDV	S PDV	Bez PDV	S PDV
TM 1 Testa di Moro RAL 8028	3,80	4,75	3,80	4,75	4,00	5,00
	083852		083869		083876	
AN 2 Antracit RAL 7016	3,80	4,75	3,80	4,75	4,00	5,00
	083456		083463		083470	
IC 3 Intenzivno crna RAL 9005	3,80	4,75	3,80	4,75	4,00	5,00
	083531		083548		083555	
OC 4 Vinsko crvena RAL 3009	3,80	4,75	3,80	4,75	4,00	5,00
	083739		083746		083753	
MH 5 Bakreno smeđa RAL 8004	3,80	4,75	3,80	4,75	4,00	5,00
	083579		083586		083593	
SB 6 Sivo bijela RAL 9002	3,80	4,75	3,80	4,75	4,00	5,00
	083814		083821		083838	
BH 7 Srebrna RAL 9006	3,80	4,75	3,80	4,75	4,00	5,00
	083494		083500		083517	
PS 8 Prašno siva RAL 7037	3,80	4,75	3,80	4,75	4,00	5,00
	083777		083784		083791	
MM 9 Metalik bakrena RAL extra	3,80	4,75	3,80	4,75	4,00	5,00
	083616		083623		083630	
BHT – P.20 10 Tamno srebrna RAL 9007	3,80	4,75	3,80	4,75	4,00	5,00
	094681		094698 *		094704	
MZ 11 Mahunasto zelena RAL 6005	3,80	4,75	3,80	4,75	4,00	5,00
	083692		083708		083715	
MOT 12 Tamno plava RAL 5010	3,80	4,75	3,80	4,75	4,00	5,00
	083654		083661		083678	
TZ 13 Travnato zelena RAL 6011	3,80	4,75	3,80	4,75	4,00	5,00
	083890 *		083906 *		083913	
Pak. u kom 	5		5		5	
Pak. u kom 	600		600		600	

* Proizvodnja po narudžbi

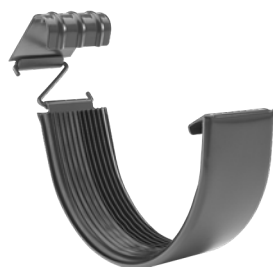

KUKA

P-PHP

Nominalna veličina	200/380		250/430		280/480		280/480	
Materijal	25/4		25/5		25/5		30/5	
Cijena u €/kom	Bez PDV	S PDV	Bez PDV	S PDV	Bez PDV	S PDV	Bez PDV	S PDV
TM Testa di Moro RAL 8028	3,30	4,13	2,95	3,69	3,15	3,94	3,45	4,31
	045362		045379		045386		045393	
AN Antracit RAL 7016	3,30	4,13	2,95	3,69	3,15	3,94	3,45	4,31
	044648		044655		044662		044679	
IC Intenzivno crna RAL 9005	3,30	4,13	2,95	3,69	3,15	3,94	3,45	4,31
	044808		044815		044822		044839	
OC Vinsko crvena RAL 3009	3,30	4,13	2,95	3,69	3,15	3,94	3,45	4,31
	045140		045157		045164		045171	
MH Bakreno smeđa RAL 8004	3,30	4,13	2,95	3,69	3,15	3,94	3,45	4,31
	044884		044891		044907		044914	
SB Sivo bijela RAL 9002	3,30	4,13	2,95	3,69	3,15	3,94	3,45	4,31
	045287		045294		045300		045317	
BH Srebrna RAL 9006	3,30	4,13	2,95	3,69	3,15	3,94	3,45	4,31
	044723		044730		044747		044754	
PS Prašno siva RAL 7037	3,30	4,13	2,95	3,69			3,45	4,31
	045225		045232				045249	
MM Metalik bakrena RAL extra	3,30	4,13	2,95	3,69			3,45	4,31
	044969		044976				044983	
BHT – P.20 Tamno srebrna RAL 9007			2,95	3,69			3,45	4,31
			095961				095978	
MZ Mahunasto zelena RAL 6005	3,30	4,13	2,95	3,69			3,45	4,31
	045089		045096				045102	
MOT Tamno plava RAL 5010	3,30	4,13	2,95	3,69			3,45	4,31
	045027		045034				045041	
TZ Travnato zelena RAL 6011	3,30	4,13	2,95	3,69			3,45	4,31
	045454 *		045461				045478	
Pak. u kom 	25		25		25		25	
Pak. u kom 	1 000		1 000		1 000		1 000	

* Proizvodnja po narudžbi



KUKA

P-PHP



Nominalna veličina	333/550		333/550		333/550		333/610		400/610		
Materijal	25/5		30/4		30/5		30/5		30/6		
Cijena u €/kom	Bez PDV	S PDV	Bez PDV	S PDV	Bez PDV	S PDV	Bez PDV	S PDV	Bez PDV	S PDV	
TM Testa di Moro RAL 8028	1	3,15	3,94	3,30	4,13	3,50	4,38	4,10	5,13	5,90	7,38
		045409		045416 *		045423		045430		045447	
AN Antracit RAL 7016	2	3,15	3,94	3,30	4,13	3,50	4,38	4,10	5,13	5,90	7,38
		044686		080127 *		044693		044709		044716	
IC Intenzivno crna RAL 9005	3	3,15	3,94			3,50	4,38	4,10	5,13	5,90	7,38
		044846				044853		044860		044877	
OC Vinsko crvena RAL 3009	4	3,15	3,94			3,50	4,38	4,10	5,13	5,90	7,38
		045188				045195		045201		045218	
MH Bakreno smeđa RAL 8004	5	3,15	3,94			3,50	4,38	4,10	5,13	5,90	7,38
		044921				044938		044945		044952	
SB Sivo bijela RAL 9002	6	3,15	3,94			3,50	4,38	4,10	5,13	5,90	7,38
		045324				045331		045348		045355	
BH Srebrna RAL 9006	7	3,15	3,94			3,50	4,38	4,10	5,13	5,90	7,38
		044761				044778		044785		044792	
PS Prašno siva RAL 7037	8					3,50	4,38	4,10	5,13	5,90	7,38
						045256		045263		045270	
MM Metalik bakrena RAL extra	9					3,50	4,38	4,10	5,13	5,90	7,38
						044990		045003		045010	
BHT – P.20 Tamno srebrna RAL 9007	10					3,50	4,38			5,90	7,38
						095985				095992	
MZ Mahunasto zelena RAL 6005	11					3,50	4,38	4,10	5,13	5,90	7,38
						045119		045126		045133	
MOT Tamno plava RAL 5010	12					3,50	4,38	4,10	5,13	5,90	7,38
						045058		045065		045072	
TZ Travnato zelena RAL 6011	13					3,50	4,38	4,10	5,13	5,90	7,38
						045485		045492		045508 *	
Pak. u kom 		25		25		25		25		25	
Pak. u kom 		1 000		1 000		1 000		1 000		500	

* Proizvodnja po narudžbi



KUKA S NOSOM



P-PHPN

Nominalna veličina	250/430		280/480		333/550	
Materijal	25/5		25/5		25/5	
Cijena u €/kom	Bez PDV	S PDV	Bez PDV	S PDV	Bez PDV	S PDV
TM 1 Testa di Moro RAL 8028	2,90	3,63	2,90	3,63	3,20	4,00
	095930		095947		095954	
AN 2 Antracit RAL 7016	2,90	3,63	2,90	3,63	3,20	4,00
	095824		095831		095848	
IC 3 Intenzivno crna RAL 9005			2,90	3,63	3,20	4,00
			095879		095886 *	
MH 5 Bakreno smeđa RAL 8004			2,90	3,63	3,20	4,00
			095893		095909	
SB 6 Sivo bijela RAL 9002			2,90	3,63	3,20	4,00
			095916		095923 *	
BH 7 Srebrna RAL 9006			2,90	3,63	3,20	4,00
			095855		095862	
PS 8 Prašno siva RAL 7037					3,20	4,00
					117496 *	
Pak. u kom 	25		25		25	
Pak. u kom 	1 000		1 000		1 000	

* Proizvodnja po narudžbi

KUKA ZA ROŽENICU S NOSOM

P-PHPNK



Nominalna veličina	250		280		333	
Materijal	25/4		25/4		25/5	
Cijena u €/kom	Bez PDV	S PDV	Bez PDV	S PDV	Bez PDV	S PDV
TM 1 Testa di Moro RAL 8028	3,15	3,94	3,35	4,19	3,55	4,44
	095435		095442		095459	
AN 2 Antracit RAL 7016	3,15	3,94	3,35	4,19	3,55	4,44
	095312		095329		095336	
IC 3 Intenzivno crna RAL 9005	3,15	3,94	3,35	4,19	3,55	4,44
	095374		095381		095398	
MH 5 Bakreno smeđa RAL 8004	3,15	3,94	3,35	4,19	3,55	4,44
	095404		095411		095428	
BH 7 Srebrna RAL 9006	3,15	3,94	3,35	4,19	3,55	4,44
	095343 *		095350		095367	
Pak. u kom 	25		25		25	
Pak. u kom 	1 000		1 000		1 000	

* Proizvodnja po narudžbi



KUKA ZA NATKROVNI ŽLIJEB

P-PHSSN

Nominalna veličina	4	
Materijal	20/6	
Cijena u €/kom	Bez PDV	S PDV
TM 1 Testa di Moro RAL 8028	8,60	10,75
	033567	
AN 2 Antracit RAL 7016	8,60	10,75
	033468	
IC 3 Intenzivno crna RAL 9005	8,60	10,75
	033482	
OC 4 Vinsko crvena RAL 3009	8,60	10,75
	033536	
MH 5 Bakreno smeđa RAL 8004	8,60	10,75
	033499	
SB 6 Sivo bijela RAL 9002	8,60	10,75
	033550	
BH 7 Srebrna RAL 9006	8,60	10,75
	033475	
PS 8 Prašno siva RAL 7037	8,60	10,75
	033543	
MM 9 Metalik bakrena RAL extra	8,60	10,75
	033505	
BHT – P.20 10 Tamno srebrna RAL 9007	8,60	10,75
	095510 *	
MZ 11 Mahunasto zelena RAL 6005	8,60	10,75
	033529	
MOT 12 Tamno plava RAL 5010	8,60	10,75
	033512 *	
TZ 13 Travnato zelena RAL 6011	8,60	10,75
	033574	
Pak. u kom 	25	
Pak. u kom 	1 000	

* Proizvodnja po narudžbi



KUKA ZA ROŽENICU

P-PHPK





Nominalna veličina	200		250		280		333		400	
Materijal	25/4		25/4		25/4		25/5		30/5	
Cijena u €/kom	Bez PDV	S PDV	Bez PDV	S PDV	Bez PDV	S PDV	Bez PDV	S PDV	Bez PDV	S PDV
TM Testa di Moro RAL 8028	3,60	4,50	3,40	4,25	3,65	4,56	3,95	4,94	5,50	6,88
	065551		065568		065575		065582		065599	
AN Antracit RAL 7016	3,60	4,50	3,40	4,25	3,65	4,56	3,95	4,94	5,50	6,88
	065056		065063		065070		065087		065094	
IC Intenzivno crna RAL 9005	3,60	4,50	3,40	4,25	3,65	4,56	3,95	4,94	5,50	6,88
	065155		065162		065179		065186		065193 *	
OC Vinsko crvena RAL 3009	3,60	4,50	3,40	4,25	3,65	4,56	3,95	4,94	5,50	6,88
	065407		065414		065421		065438		065445	
MH Bakreno smeđa RAL 8004	3,60	4,50	3,40	4,25	3,65	4,56	3,95	4,94	5,50	6,88
	065209		065216		065223		065230		065247 *	
SB Sivo bijela RAL 9002	3,60	4,50	3,40	4,25	3,65	4,56	3,95	4,94	5,50	6,88
	065506		065513		065520		065537		065544	
BH Srebrna RAL 9006	3,60	4,50	3,40	4,25	3,65	4,56	3,95	4,94	5,50	6,88
	065100		065117		065124		065131		065148	
PS Prašno siva RAL 7037	3,60	4,50	3,40	4,25	3,65	4,56	3,95	4,94	5,50	6,88
	065452		065469		065476		065483		065490	
MM Metalik bakrena RAL extra	3,60	4,50	3,40	4,25	3,65	4,56	3,95	4,94	5,50	6,88
	065254		065261		065278		065285		065292 *	
BHT – P.20 Tamno srebrna RAL 9007			3,40	4,25	3,65	4,56	3,95	4,94		
			095251		095268		095275			
MZ Mahunasto zelena RAL 6005	3,60	4,50	3,40	4,25	3,65	4,56	3,95	4,94	5,50	6,88
	065353		065360		065377		065384		065391 *	
MOT Tamno plava RAL 5010	3,60	4,50	3,40	4,25	3,65	4,56	3,95	4,94	5,50	6,88
	065308 *		065315		065322		065339		065346	
TZ Travnato zelena RAL 6011	3,60	4,50	3,40	4,25	3,65	4,56	3,95	4,94	5,50	6,88
	065605 *		065612 *		065629 *		065636 *		065643 *	
Pak. u kom	25		25		25		25		20	
Pak. u kom	1 000		1 000		1 000		1 000		800	

* Proizvodnja po narudžbi

KUTNIK VANJSKI

P-PRA



Nominalna veličina	200		250		280		333		400	
	Bez PDV	S PDV	Bez PDV	S PDV	Bez PDV	S PDV	Bez PDV	S PDV	Bez PDV	S PDV
TM 1 Testa di Moro RAL 8028	11,90	14,88	11,70	14,63	11,80	14,75	11,90	14,88	29,90	37,38
	075673		075680		075697		075703		075710	
AN 2 Antracit RAL 7016	11,90	14,88	11,70	14,63	11,80	14,75	11,90	14,88	29,90	37,38
	075178		075185		075192		075208		075215	
IC 3 Intenzivno crna RAL 9005	11,90	14,88	11,70	14,63	11,80	14,75	11,90	14,88	29,90	37,38
	075260		075284		075291		075307		075314	
OC 4 Vinsko crvena RAL 3009	11,90	14,88	11,70	14,63	11,80	14,75	11,90	14,88	29,90	37,38
	075529		075536		075543		075567		075550	
MH 5 Bakreno smeđa RAL 8004	11,90	14,88	11,70	14,63	11,80	14,75	11,90	14,88	29,90	37,38
	075321		075338		075345		075352		075369	
SB 6 Sivo bijela RAL 9002	11,90	14,88	11,70	14,63	11,80	14,75	11,90	14,88	29,90	37,38
	075635		075628		075642		075659		075666	
BH 7 Srebrna RAL 9006	11,90	14,88	11,70	14,63	11,80	14,75	11,90	14,88	29,90	37,38
	075222		075239		075246		075253		075277	
PS 8 Prašno siva RAL 7037	11,90	14,88	11,70	14,63	11,80	14,75	11,90	14,88	29,90	37,38
	075574		075581		075598		075604		075611	
MM 9 Metalik bakrena RAL extra	11,90	14,88	11,70	14,63	11,80	14,75	11,90	14,88	29,90	37,38
	075376		075383		075390		075406		075413	
BHT – P.20 10 Tamno srebrna RAL 9007			11,70	14,63	11,80	14,75	11,90	14,88	29,90	37,38
			094384		094391 *		094407		110695	
MZ 11 Mahunasto zelena RAL 6005	11,90	14,88	11,70	14,63	11,80	14,75	11,90	14,88	29,90	37,38
	075475		075482		075499		075505		075512	
MOT 12 Tamno plava RAL 5010	11,90	14,88	11,70	14,63	11,80	14,75	11,90	14,88	29,90	37,38
	075420		075437		075444		075451		075468	
TZ 13 Travnato zelena RAL 6011	11,90	14,88	11,70	14,63	11,80	14,75	11,90	14,88	29,90	37,38
	075727 *		075734		075741		075758		075765 *	
Pak. u kom 	5		5		5		5		5	
Pak. u kom 	150		150		150		150		150	

* Proizvodnja po narudžbi



KUTNIK UNUTARNJI

P-PRI



Nominalna veličina	200		250		280		333		400	
	Bez PDV	S PDV	Bez PDV	S PDV	Bez PDV	S PDV	Bez PDV	S PDV	Bez PDV	S PDV
TM 1 Testa di Moro RAL 8028	11,90	14,88	11,70	14,63	11,80	14,75	11,90	14,88	29,90	37,38
	076281		076274		076298		076304		076311	
AN 2 Antracit RAL 7016	11,90	14,88	11,70	14,63	11,80	14,75	11,90	14,88	29,90	37,38
	075772		075789		075796		075802		075819	
IC 3 Intenzivno crna RAL 9005	11,90	14,88	11,70	14,63	11,80	14,75	11,90	14,88	29,90	37,38
	075871		075888		075895		075901		075918	
OC 4 Vinsko crvena RAL 3009	11,90	14,88	11,70	14,63	11,80	14,75	11,90	14,88	29,90	37,38
	076120		076137		076144		076168		076151	
MH 5 Bakreno smeđa RAL 8004	11,90	14,88	11,70	14,63	11,80	14,75	11,90	14,88	29,90	37,38
	075925		075932		075949		075956		075963	
SB 6 Sivo bijela RAL 9002	11,90	14,88	11,70	14,63	11,80	14,75	11,90	14,88	29,90	37,38
	076229		076236		076243		076250		076267	
BH 7 Srebrna RAL 9006	11,90	14,88	11,70	14,63	11,80	14,75	11,90	14,88	29,90	37,38
	075826		075833		075840		075857		075864	
PS 8 Prašno siva RAL 7037	11,90	14,88	11,70	14,63	11,80	14,75	11,90	14,88	29,90	37,38
	076175		076199		076182		076205		076212	
MM 9 Metalik bakrena RAL extra	11,90	14,88	11,70	14,63	11,80	14,75	11,90	14,88	29,90	37,38
	075970		075987		075994		076007		076014	
BHT – P.20 10 Tamno srebrna RAL 9007			11,70	14,63	11,80	14,75	11,90	14,88	29,90	37,38
			094414		094421 *		094438		110688	
MZ 11 Mahunasto zelena RAL 6005	11,90	14,88	11,70	14,63	11,80	14,75	11,90	14,88	29,90	37,38
	076076		076083		076090		076106		076113	
MOT 12 Tamno plava RAL 5010	11,90	14,88	11,70	14,63	11,80	14,75	11,90	14,88	29,90	37,38
	076021 *		076038		076045		076052		076069	
TZ 13 Travnato zelena RAL 6011	11,90	14,88	11,70	14,63	11,80	14,75	11,90	14,88	29,90	37,38
	076335 *		076328		076342		076359		076366 *	
Pak. u kom 	5		5		5		5		5	
Pak. u kom 	150		150		150		150		150	

* Proizvodnja po narudžbi



ČELO ŽLIJEBA

P-PCL



Nominalna veličina	200		250		280		333		400	
	Bez PDV	S PDV	Bez PDV	S PDV	Bez PDV	S PDV	Bez PDV	S PDV	Bez PDV	S PDV
TM 1 Testa di Moro RAL 8028	1,45	1,81	1,30	1,63	1,40	1,75	1,45	1,81	2,25	2,81
	003164		003171		003188		003195		003201	
AN 2 Antracit RAL 7016	1,45	1,81	1,30	1,63	1,40	1,75	1,45	1,81	2,25	2,81
	002662		002679		002686		002693		002709	
IC 3 Intenzivno crna RAL 9005	1,45	1,81	1,30	1,63	1,40	1,75	1,45	1,81	2,25	2,81
	002761		002778		002785		002792		002808	
OC 4 Vinsko crvena RAL 3009	1,45	1,81	1,30	1,63	1,40	1,75	1,45	1,81	2,25	2,81
	003010		003027		003034		003041		003058	
MH 5 Bakreno smeđa RAL 8004	1,45	1,81	1,30	1,63	1,40	1,75	1,45	1,81	2,25	2,81
	002815		002822		002839		002846		002853	
SB 6 Sivo bijela RAL 9002	1,45	1,81	1,30	1,63	1,40	1,75	1,45	1,81	2,25	2,81
	003119		003126		003133		003140		003157	
BH 7 Srebrna RAL 9006	1,45	1,81	1,30	1,63	1,40	1,75	1,45	1,81	2,25	2,81
	002716		002723		002730		002747		002754	
PS 8 Prašno siva RAL 7037	1,45	1,81	1,30	1,63	1,40	1,75	1,45	1,81	2,25	2,81
	003065		003072		003089		003096		003102	
MM 9 Metalik bakrena RAL extra	1,45	1,81	1,30	1,63	1,40	1,75	1,45	1,81	2,25	2,81
	002860		002877		002884		002891		002907	
BHT – P.20 10 Tamno srebrna RAL 9007			1,30	1,63	1,40	1,75	1,45	1,81	2,25	2,81
			094568		094575 *		094582		094599	
MZ 11 Mahunasto zelena RAL 6005	1,45	1,81	1,30	1,63	1,40	1,75	1,45	1,81	2,25	2,81
	002969		002976		002983		002990		003003	
MOT 12 Tamno plava RAL 5010	1,45	1,81	1,30	1,63	1,40	1,75	1,45	1,81	2,25	2,81
	002914		002921		002938		002945		002952	
TZ 13 Travnato zelena RAL 6011	1,45	1,81	1,30	1,63	1,40	1,75	1,45	1,81	2,25	2,81
	003218 *		003225		003232		003249		003256	
Pak. u kom 	6/60		6/60		6/60		6/60		4/40	
Pak. u kom 	1 440		1 440		1 440		1 440		960	

* Proizvodnja po narudžbi



ČELO SA GUMOM

P-PCLG



Nominalna veličina	250		280		333	
	Bez PDV	S PDV	Bez PDV	S PDV	Bez PDV	S PDV
TM 1 Testa di Moro RAL 8028	2,65	3,31	2,90	3,63	3,00	3,75
	004338		004345		004352	
AN 2 Antracit RAL 7016	2,65	3,31	2,90	3,63	3,00	3,75
	004031		004048		004055	
IC 3 Intenzivno crna RAL 9005	2,65	3,31	2,90	3,63	3,00	3,75
	004093		004109		004116	
OC 4 Vinsko crvena RAL 3009	2,65	3,31	2,90	3,63	3,00	3,75
	004246		004253		004260	
MH 5 Bakreno smeđa RAL 8004	2,65	3,31	2,90	3,63	3,00	3,75
	004123		004130		004147	
SB 6 Sivo bijela RAL 9002	2,65	3,31	2,90	3,63	3,00	3,75
	004307		004314		004321	
BH 7 Srebrna RAL 9006	2,65	3,31	2,90	3,63	3,00	3,75
	004062		004079		004086	
PS 8 Prašno siva RAL 7037	2,65	3,31	2,90	3,63	3,00	3,75
	004277		004284		004291	
MM 9 Metalik bakrena RAL extra	2,65	3,31	2,90	3,63	3,00	3,75
	004154		004161		004178	
BHT – P.20 10 Tamno srebrna RAL 9007	2,65	3,31	2,90	3,63	3,00	3,75
	094605		094612 *		094629	
MZ 11 Mahunasto zelena RAL 6005	2,65	3,31	2,90	3,63	3,00	3,75
	004215		004222		004239	
MOT 12 Tamno plava RAL 5010	2,65	3,31	2,90	3,63	3,00	3,75
	004185		004192		004208	
TZ 13 Travnato zelena RAL 6011	2,65	3,31	2,90	3,63	3,00	3,75
	004369 *		004376 *		004383 *	
Pak. u kom 	4/40		4/40		4/40	
Pak. u kom 	960		960		960	



* Proizvodnja po narudžbi

ISPUSNI KOTLIĆ

P-PKL

Nominalna veličina	200/60		250/60		250/80		280/80		280/100	
	Bez PDV	S PDV	Bez PDV	S PDV	Bez PDV	S PDV	Bez PDV	S PDV	Bez PDV	S PDV
TM 1 Testa di Moro RAL 8028	7,40	9,25	9,00	11,25	6,60	8,25	7,20	9,00	7,20	9,00
	067357		067364		067371		067388		067395	
AN 2 Antracit RAL 7016	7,40	9,25	9,00	11,25	6,60	8,25	7,20	9,00	7,20	9,00
	066251		066268		066275		066282		066299	
IC 3 Intenzivno crna RAL 9005	7,40	9,25	9,00	11,25	6,60	8,25	7,20	9,00	7,20	9,00
	066473		066480		066497		066503		066510	
OC 4 Vinsko crvena RAL 3009	7,40	9,25	9,00	11,25	6,60	8,25	7,20	9,00	7,20	9,00
	067029		067036		067043		067050		067067	
MH 5 Bakreno smeđa RAL 8004	7,40	9,25	9,00	11,25	6,60	8,25	7,20	9,00	7,20	9,00
	066589		066596		066602		066619		066626	
SB 6 Sivo bijela RAL 9002	7,40	9,25	9,00	11,25	6,60	8,25	7,20	9,00	7,20	9,00
	067241		067258		067265		067272		067289	
BH 7 Srebrna RAL 9006	7,40	9,25	9,00	11,25	6,60	8,25	7,20	9,00	7,20	9,00
	066367		066374		066381		066398		066404	
PS 8 Prašno siva RAL 7037	7,40	9,25	9,00	11,25	6,60	8,25	7,20	9,00	7,20	9,00
	067135		067142 *		067159		067166		067173	
MM 9 Metalik bakrena RAL extra	7,40	9,25	9,00	11,25	6,60	8,25	7,20	9,00	7,20	9,00
	066695		066701 *		066718		066725		066732	
BHT – P.20 10 Tamno srebrna RAL 9007	7,40	9,25	9,00	11,25	6,60	8,25	7,20	9,00	7,20	9,00
	119728 *		119735 *		094469		094476		094483	
MZ 11 Mahunasto zelena RAL 6005	7,40	9,25	9,00	11,25	6,60	8,25	7,20	9,00	7,20	9,00
	066916		066923		066930		066947		066954	
MOT 12 Tamno plava RAL 5010	7,40	9,25	9,00	11,25	6,60	8,25	7,20	9,00	7,20	9,00
	066800 *		066817 *		066824		066831		066848	
TZ 13 Travnato zelena RAL 6011	7,40	9,25	9,00	11,25	6,60	8,25	7,20	9,00	7,20	9,00
	067463 *		067470 *		067487		067494 *		067500	
Pak. u kom 	20		20		20		20		20	
Pak. u kom 	600		600		600		600		600	

* Proizvodnja po narudžbi



ISPUSNI KOTLIĆ

P-PKL



Nominalna veličina	333/80		333/100		333/120	
	Bez PDV	S PDV	Bez PDV	S PDV	Bez PDV	S PDV
TM 1 Testa di Moro RAL 8028	8,40	10,50	7,95	9,94	9,50	11,88
	067401		067418		067425	
AN 2 Antracit RAL 7016	8,40	10,50	7,95	9,94	9,50	11,88
	066305		066312		066329	
IC 3 Intenzivno crna RAL 9005	8,40	10,50	7,95	9,94	9,50	11,88
	066527		066534		066541	
OC 4 Vinsko crvena RAL 3009	8,40	10,50	7,95	9,94	9,50	11,88
	067074		067081		067098	
MH 5 Bakreno smeđa RAL 8004	8,40	10,50	7,95	9,94	9,50	11,88
	066633		066640		066657	
SB 6 Sivo bijela RAL 9002	8,40	10,50	7,95	9,94	9,50	11,88
	067296		067302		067326	
BH 7 Srebrna RAL 9006	8,40	10,50	7,95	9,94	9,50	11,88
	066411		066428		066435	
PS 8 Prašno siva RAL 7037	8,40	10,50	7,95	9,94	9,50	11,88
	067180		067197		067203	
MM 9 Metalik bakrena RAL extra	8,40	10,50	7,95	9,94	9,50	11,88
	066749		066756		066763	
BHT – P.20 10 Tamno srebrna RAL 9007	8,40	10,50	7,95	9,94	9,50	11,88
	094490 *		094506		094513	
MZ 11 Mahunasto zelena RAL 6005	8,40	10,50	7,95	9,94	9,50	11,88
	066961		066978		066985	
MOT 12 Tamno plava RAL 5010	8,40	10,50	7,95	9,94	9,50	11,88
	066855 *		066862		066879	
TZ 13 Travnato zelena RAL 6011	8,40	10,50	7,95	9,94	9,50	11,88
	067517 *		067524		067531	
Pak. u kom	20		20		15	
Pak. u kom	600		600		300	

* Proizvodnja po narudžbi

ISPUSNI KOTLIĆ

P-PKL

Nominalna veličina	400/100		400/120		400/150	
	Bez PDV	S PDV	Bez PDV	S PDV	Bez PDV	S PDV
TM 1 Testa di Moro RAL 8028	19,00	23,75	19,00	23,75	21,50	26,88
	067432		067449		067456	
AN 2 Antracit RAL 7016	19,00	23,75	19,00	23,75	21,50	26,88
	066336		066343		066350	
IC 3 Intenzivno crna RAL 9005	19,00	23,75	19,00	23,75	21,50	26,88
	066558		066565		066572	
OC 4 Vinsko crvena RAL 3009	19,00	23,75	19,00	23,75	21,50	26,88
	067104 *		067111		067128	
MH 5 Bakreno smeđa RAL 8004	19,00	23,75	19,00	23,75	21,50	26,88
	066664 *		066671		066688	
SB 6 Sivo bijela RAL 9002	19,00	23,75	19,00	23,75	21,50	26,88
	067319		067333		067340	
BH 7 Srebrna RAL 9006	19,00	23,75	19,00	23,75	21,50	26,88
	066442		066459		066466	
PS 8 Prašno siva RAL 7037	19,00	23,75	19,00	23,75	21,50	26,88
	067210		067227		067234	
MM 9 Metalik bakrena RAL extra	19,00	23,75	19,00	23,75	21,50	26,88
	066770 *		066787 *		066794 *	
BHT – P.20 10 Tamno srebrna RAL 9007	19,00	23,75	19,00	23,75	21,50	26,88
	119742 *		094520		094667	
MZ 11 Mahunasto zelena RAL 6005	19,00	23,75	19,00	23,75	21,50	26,88
	066992 *		067005		067012	
MOT 12 Tamno plava RAL 5010	19,00	23,75	19,00	23,75	21,50	26,88
	066886 *		066893		066909	
TZ 13 Travnato zelena RAL 6011	19,00	23,75	19,00	23,75	21,50	26,88
	067548 *		067555		067562 *	
Pak. u kom 	15		15		15	
Pak. u kom 	300		300		300	

* Proizvodnja po narudžbi



POCINK POLYESTER

NOVI PRIČVRŠNI
SISTEM FEDER OMOGUĆUJE
LAGANO OKRETANJE KOLJENA
DO TRAŽENOG SMJERA
TE JE POUZDANO U SVAKOJ
POZICIJI. LAGANA MONTAŽA NA
BILO KAKVO KOLJENO
BEZ NITANJA.

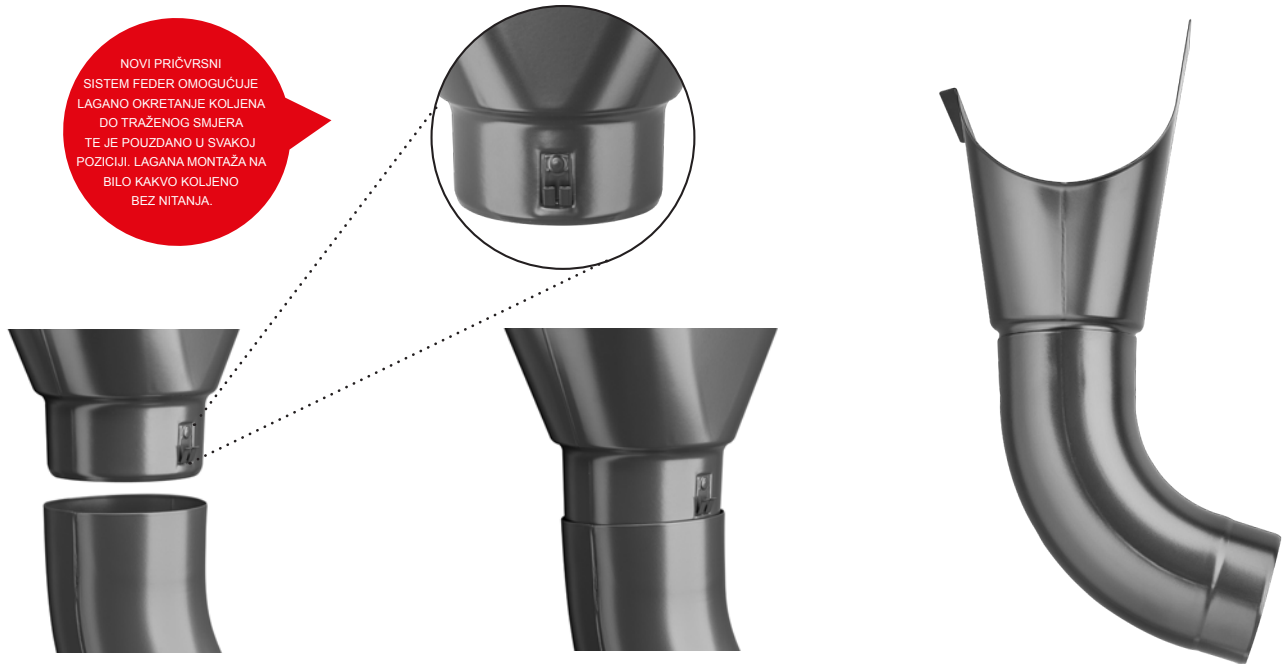

POCINK
POLYESTER



SABIRNI KOTLIĆ CENTRALNI

IT-KLZF C

Nominalna veličina	60		80		100		120	
	Bez PDV	S PDV	Bez PDV	S PDV	Bez PDV	S PDV	Bez PDV	S PDV
TM 1 Testa di Moro RAL 8028	14,90	18,63	15,00	18,75	16,20	20,25	21,60	27,00
	077028 *		077042 *		077066 *		077080 *	
AN 2 Antracit RAL 7016	14,90	18,63	15,00	18,75	16,20	20,25	21,60	27,00
	076540 *		076564 *		076588 *		076601 *	
IC 3 Intenzivno crna RAL 9005	14,90	18,63	15,00	18,75	16,20	20,25	21,60	27,00
	076700 *		076724 *		076748 *		076762 *	
OC 4 Vinsko crvena RAL 3009	14,90	18,63	15,00	18,75	16,20	20,25	21,60	27,00
	076861 *		076885 *		076908 *		076922 *	
MH 5 Bakreno smeđa RAL 8004	14,90	18,63	15,00	18,75	16,20	20,25	21,60	27,00
	076786 *		076809 *		076823 *		076847 *	
SB 6 Sivo bijela RAL 9002	14,90	18,63	15,00	18,75	16,20	20,25	21,60	27,00
	076946 *		076960 *		076984 *		077004 *	
BH 7 Srebrna RAL 9006	14,90	18,63	15,00	18,75	16,20	20,25	21,60	27,00
	076625 *		076649 *		076663 *		076687 *	
PS 8 Prašno siva RAL 7037								
MM 9 Metalik bakrena RAL extra								
BHT – P.20 10 Tamno srebrna RAL 9007								
MZ 11 Mahunasto zelena RAL 6005								
MOT 12 Tamno plava RAL 5010								
TZ 13 Travnato zelena RAL 6011								
Pak. u kom 	10		10		10		10	
Pak. u kom 	300		300		200		200	

* Proizvodnja po narudžbi



SABIRNI KOTLIĆ BOČNI

IT-KLZF B





Nominalna veličina	60		80		100		120	
	Bez PDV	S PDV	Bez PDV	S PDV	Bez PDV	S PDV	Bez PDV	S PDV
TM 1 Testa di Moro RAL 8028	14,90	18,63	15,00	18,75	16,20	20,25	21,60	27,00
	077011 *		077035 *		077059 *		077073 *	
AN 2 Antracit RAL 7016	14,90	18,63	15,00	18,75	16,20	20,25	21,60	27,00
	076533 *		076557 *		076571 *		076595 *	
IC 3 Intenzivno crna RAL 9005	14,90	18,63	15,00	18,75	16,20	20,25	21,60	27,00
	076694 *		076717 *		076731 *		076755 *	
OC 4 Vinsko crvena RAL 3009	14,90	18,63	15,00	18,75	16,20	20,25	21,60	27,00
	076854 *		076878 *		076892 *		076915 *	
MH 5 Bakreno smeđa RAL 8004	14,90	18,63	15,00	18,75	16,20	20,25	21,60	27,00
	076779 *		076793 *		076816 *		076830 *	
SB 6 Sivo bijela RAL 9002	14,90	18,63	15,00	18,75	16,20	20,25	21,60	27,00
	076939 *		076953 *		076977 *		076991 *	
BH 7 Srebrna RAL 9006	14,90	18,63	15,00	18,75	16,20	20,25	21,60	27,00
	076618 *		076632 *		076656 *		076670 *	
PS 8 Prašno siva RAL 7037								
MM 9 Metalik bakrena RAL extra								
BHT – P.20 10 Tamno srebrna RAL 9007								
MZ 11 Mahunasto zelena RAL 6005								
MOT 12 Tamno plava RAL 5010								
TZ 13 Travnato zelena RAL 6011								
Pak. u kom	10		10		10		10	
Pak. u kom	300		300		200		200	

* Proizvodnja po narudžbi

GRLO

P-PHRD

Nominalna veličina	80		100		120	
	Bez PDV	S PDV	Bez PDV	S PDV	Bez PDV	S PDV
TM 1 Testa di Moro RAL 8028	1,65	2,06	1,75	2,19	2,10	2,63
	066015		066022		066039	
AN 2 Antracit RAL 7016	1,65	2,06	1,75	2,19	2,10	2,63
	065711		065728		065735 *	
IC 3 Intenzivno crna RAL 9005	1,65	2,06	1,75	2,19	2,10	2,63
	065773 *		065780		065797 *	
OC 4 Vinsko crvena RAL 3009	1,65	2,06	1,75	2,19	2,10	2,63
	065926 *		065933		065940 *	
MH 5 Bakreno smeđa RAL 8004	1,65	2,06	1,75	2,19	2,10	2,63
	065803 *		065810		065827 *	
SB 6 Sivo bijela RAL 9002	1,65	2,06	1,75	2,19	2,10	2,63
	065988 *		065995 *		066008 *	
BH 7 Srebrna RAL 9006	1,65	2,06	1,75	2,19	2,10	2,63
	065742 *		065759 *		065766 *	
PS 8 Prašno siva RAL 7037	1,65	2,06	1,75	2,19	2,10	2,63
	065957 *		065964 *		065971 *	
MM 9 Metalik bakrena RAL extra	1,65	2,06	1,75	2,19	2,10	2,63
	065834 *		065841 *		065858 *	
BHT – P.20 10 Tamno srebrna RAL 9007						
MZ 11 Mahunasto zelena RAL 6005	1,65	2,06	1,75	2,19	2,10	2,63
	065896 *		065902 *		065919 *	
MOT 12 Tamno plava RAL 5010	1,65	2,06	1,75	2,19	2,10	2,63
	065865 *		065872 *		065889 *	
TZ 13 Travnato zelena RAL 6011	1,65	2,06	1,75	2,19	2,10	2,63
	066046 *		066053 *		066060 *	
Pak. u kom 	25		25		15	
Pak. u kom 	1 000		1 000		750	



* Proizvodnja po narudžbi



INOX ZADRŽAČ SMEĆA

N-NZN



Nominalna veličina	EAN broj narudžbe	Pak. u kom		Cijena [€/kom]	
				Bez PDV	S PDV
60	001153	30	2 160	5,55	6,94
80	001160	20	1 440	5,60	7,00
100	001177	15	1 080	5,70	7,13
120	001184	10	720	6,20	7,75
150	001191	5	360	9,80	12,25



SABIRNI KOTLIĆ DESIGN

P-PKLZ DE

Nominalna veličina	80		100		120	
	Bez PDV	S PDV	Bez PDV	S PDV	Bez PDV	S PDV
TM 1 Testa di Moro RAL 8028	58,00	72,50	58,00	72,50	64,00	80,00
	027702		027726		027740	
AN 2 Antracit RAL 7016	58,00	72,50	58,00	72,50	64,00	80,00
	026200		026224		026248	
IC 3 Intenzivno crna RAL 9005	58,00	72,50	58,00	72,50	64,00	80,00
	026507		026521		026545	
OC 4 Vinsko crvena RAL 3009	58,00	72,50	58,00	72,50	64,00	80,00
	027252 *		027276		027290	
MH 5 Bakreno smeđa RAL 8004	58,00	72,50	58,00	72,50	64,00	80,00
	026651		026675		026699	
SB 6 Sivo bijela RAL 9002	58,00	72,50	58,00	72,50	64,00	80,00
	027559 *		027573		027597	
BH 7 Srebrna RAL 9006	58,00	72,50	58,00	72,50	64,00	80,00
	026354		026378		026392	
PS 8 Prašno siva RAL 7037	58,00	72,50	58,00	72,50	64,00	80,00
	027405		027429		027443	
MM 9 Metalik bakrena RAL extra	58,00	72,50	58,00	72,50	64,00	80,00
	026804 *		026828		026842	
BHT – P.20 10 Tamno srebrna RAL 9007	58,00	72,50	58,00	72,50	64,00	80,00
	096210		096265		096319	
MZ 11 Mahunasto zelena RAL 6005	58,00	72,50	58,00	72,50	64,00	80,00
	027108 *		027122		027146 *	
MOT 12 Tamno plava RAL 5010	58,00	72,50	58,00	72,50	64,00	80,00
	026958 *		026972		027009 *	
TZ 13 Travnato zelena RAL 6011	58,00	72,50	58,00	72,50	64,00	80,00
	027856 *		027870 *		027894 *	
Pak. u kom 	2		2		2	
Pak. u kom 	36		36		36	

* Proizvodnja po narudžbi



SABIRNI KOTLIĆ DESIGN EKSCENTRIČNI

P-PKLZ DX





Nominalna veličina	80		100		120	
	Bez PDV	S PDV	Bez PDV	S PDV	Bez PDV	S PDV
TM 1 Testa di Moro RAL 8028	72,00	90,00	72,00	90,00	74,00	92,50
	027764		027795		027825	
AN 2 Antracit RAL 7016	72,00	90,00	72,00	90,00	74,00	92,50
	026262		026293		026323	
IC 3 Intenzivno crna RAL 9005	72,00	90,00	72,00	90,00	74,00	92,50
	026569		026590		026620 *	
OC 4 Vinsko crvena RAL 3009	72,00	90,00	72,00	90,00	74,00	92,50
	027313		027344		027375 *	
MH 5 Bakreno smeđa RAL 8004	72,00	90,00	72,00	90,00	74,00	92,50
	026712 *		026743 *		026774 *	
SB 6 Sivo bijela RAL 9002	72,00	90,00	72,00	90,00	74,00	92,50
	027610 *		027641		027672	
BH 7 Srebrna RAL 9006	72,00	90,00	72,00	90,00	74,00	92,50
	026415 *		026446		026477	
PS 8 Prašno siva RAL 7037	72,00	90,00	72,00	90,00	74,00	92,50
	027467 *		027498		027528	
MM 9 Metalik bakrena RAL extra	72,00	90,00	72,00	90,00	74,00	92,50
	026866 *		026897		026927 *	
BHT – P.20 10 Tamno srebrna RAL 9007	72,00	90,00	72,00	90,00	74,00	92,50
	096203 *		096258		096302	
MZ 11 Mahunasto zelena RAL 6005	72,00	90,00	72,00	90,00	74,00	92,50
	027160 *		027191 *		027221 *	
MOT 12 Tamno plava RAL 5010	72,00	90,00	72,00	90,00	74,00	92,50
	027016 *		027047 *		027078 *	
TZ 13 Travnato zelena RAL 6011	72,00	90,00	72,00	90,00	74,00	92,50
	027917 *		027948 *		027979 *	
Pak. u kom 	2		2		2	
Pak. u kom 	36		36		36	

* Proizvodnja po narudžbi

SABIRNI KOTLIĆ KUBICKI

P-PKLZ KU





Nominalna veličina	80		100		120	
	Bez PDV	S PDV	Bez PDV	S PDV	Bez PDV	S PDV
TM 1 Testa di Moro RAL 8028	88,00	110,00	88,00	110,00	94,00	117,50
	027719 *		027733		027757	
AN 2 Antracit RAL 7016	88,00	110,00	88,00	110,00	94,00	117,50
	026217		026231		026255	
IC 3 Intenzivno crna RAL 9005	88,00	110,00	88,00	110,00	94,00	117,50
	026514		026538		026552	
OC 4 Vinsko crvena RAL 3009	88,00	110,00	88,00	110,00	94,00	117,50
	027269 *		027283 *		027306	
MH 5 Bakreno smeđa RAL 8004	88,00	110,00	668,80	836,00	94,00	117,50
	026668 *		026682 *		026705 *	
SB 6 Sivo bijela RAL 9002	88,00	110,00	88,00	110,00	94,00	117,50
	027566 *		027580 *		027603 *	
BH 7 Srebrna RAL 9006	88,00	110,00	88,00	110,00	94,00	117,50
	026361 *		026385		026408	
PS 8 Prašno siva RAL 7037	88,00	110,00	88,00	110,00	94,00	117,50
	027412 *		027436 *		027450	
MM 9 Metalik bakrena RAL extra	88,00	110,00	88,00	110,00	94,00	117,50
	026811 *		026835 *		026859 *	
BHT – P.20 10 Tamno srebrna RAL 9007	88,00	110,00	88,00	110,00	94,00	117,50
	096241 *		096296 *		096340 *	
MZ 11 Mahunasto zelena RAL 6005	88,00	110,00	88,00	110,00	94,00	117,50
	027115 *		027139 *		027153 *	
MOT 12 Tamno plava RAL 5010	88,00	110,00	88,00	110,00	94,00	117,50
	026965 *		026989 *		026996 *	
TZ 13 Travnato zelena RAL 6011	88,00	110,00	88,00	110,00	94,00	117,50
	027863 *		027887 *		027900 *	
Pak. u kom 	2		2		2	
Pak. u kom 	36		36		36	

* Proizvodnja po narudžbi

SABIRNI KOTLIĆ KUBICKI EKSCENTRIČAN

P-PKLZ KX





Nominalna veličina	80		100		120	
	Bez PDV	S PDV	Bez PDV	S PDV	Bez PDV	S PDV
TM 1 Testa di Moro RAL 8028	88,00	110,00	88,00	110,00	94,00	117,50
	027788		027818		027849	
AN 2 Antracit RAL 7016	88,00	110,00	88,00	110,00	94,00	117,50
	026286		026316		026347	
IC 3 Intenzivno crna RAL 9005	88,00	110,00	88,00	110,00	94,00	117,50
	026583		026613		026644 *	
OC 4 Vinsko crvena RAL 3009	88,00	110,00	88,00	110,00	94,00	117,50
	027337 *		027368		027399	
MH 5 Bakreno smeđa RAL 8004	88,00	110,00	88,00	110,00	94,00	117,50
	026736		026767		026798 *	
SB 6 Sivo bijela RAL 9002	88,00	110,00	88,00	110,00	94,00	117,50
	027634 *		027665		027696	
BH 7 Srebrna RAL 9006	88,00	110,00	88,00	110,00	94,00	117,50
	026439 *		026460		026491	
PS 8 Prašno siva RAL 7037	88,00	110,00	88,00	110,00	94,00	117,50
	027481 *		027511		027542	
MM 9 Metalik bakrena RAL extra	88,00	110,00	88,00	110,00	94,00	117,50
	026880 *		026910		026941 *	
BHT – P.20 10 Tamno srebrna RAL 9007	88,00	110,00	88,00	110,00	94,00	117,50
	096227		096272		096326	
MZ 11 Mahunasto zelena RAL 6005	88,00	110,00	88,00	110,00	94,00	117,50
	027184 *		027214		027245 *	
MOT 12 Tamno plava RAL 5010	88,00	110,00	88,00	110,00	94,00	117,50
	027030 *		027061 *		027092 *	
TZ 13 Travnato zelena RAL 6011	88,00	110,00	88,00	110,00	94,00	117,50
	027931 *		027962		027993 *	
Pak. u kom 	2		2		2	
Pak. u kom 	36		36		36	

* Proizvodnja po narudžbi

SABIRNI KOTLIĆ KUBICKI EKSCENTRIČNI S OTVOROM P-PKLZ KXV



Nominalna veličina	80		100		120	
	Bez PDV	S PDV	Bez PDV	S PDV	Bez PDV	S PDV
TM 1 Testa di Moro RAL 8028	115,00	143,75	115,00	143,75	115,00	143,75
	027771 *		027801 *		027832 *	
AN 2 Antracit RAL 7016	115,00	143,75	115,00	143,75	115,00	143,75
	026279 *		026309 *		026330 *	
IC 3 Intenzivno crna RAL 9005	115,00	143,75	115,00	143,75	115,00	143,75
	026576 *		26 606,00		026637 *	
OC 4 Vinsko crvena RAL 3009	115,00	143,75	115,00	143,75	115,00	143,75
	027320 *		027351 *		027382 *	
MH 5 Bakreno smeđa RAL 8004	115,00	143,75	115,00	143,75	115,00	143,75
	026729 *		026750 *		026781 *	
SB 6 Sivo bijela RAL 9002	115,00	143,75	115,00	143,75	115,00	143,75
	027627 *		027658 *		027689 *	
BH 7 Srebrna RAL 9006	115,00	143,75	115,00	143,75	115,00	143,75
	026422 *		026453 *		026484 *	
PS 8 Prašno siva RAL 7037	115,00	143,75	115,00	143,75	115,00	143,75
	027474 *		027504 *		027535 *	
MM 9 Metalik bakrena RAL extra	115,00	143,75	115,00	143,75	115,00	143,75
	026873 *		026903 *		026934 *	
BHT – P.20 10 Tamno srebrna RAL 9007	115,00	143,75	115,00	143,75	115,00	143,75
	096234 *		096289 *		096333 *	
MZ 11 Mahunasto zelena RAL 6005	115,00	143,75	115,00	143,75	115,00	143,75
	027177 *		027207 *		027238 *	
MOT 12 Tamno plava RAL 5010	115,00	143,75	115,00	143,75	115,00	143,75
	027023 *		027054 *		027085 *	
TZ 13 Travnato zelena RAL 6011	115,00	143,75	115,00	143,75	115,00	143,75
	027924 *		027955 *		027986 *	
Pak. u kom 	2		2		2	
Pak. u kom 	36		36		36	

* Proizvodnja po narudžbi

GUMA ZA BRTLJENJE SABIRNOG KOTLIĆA

P-PKLZ T



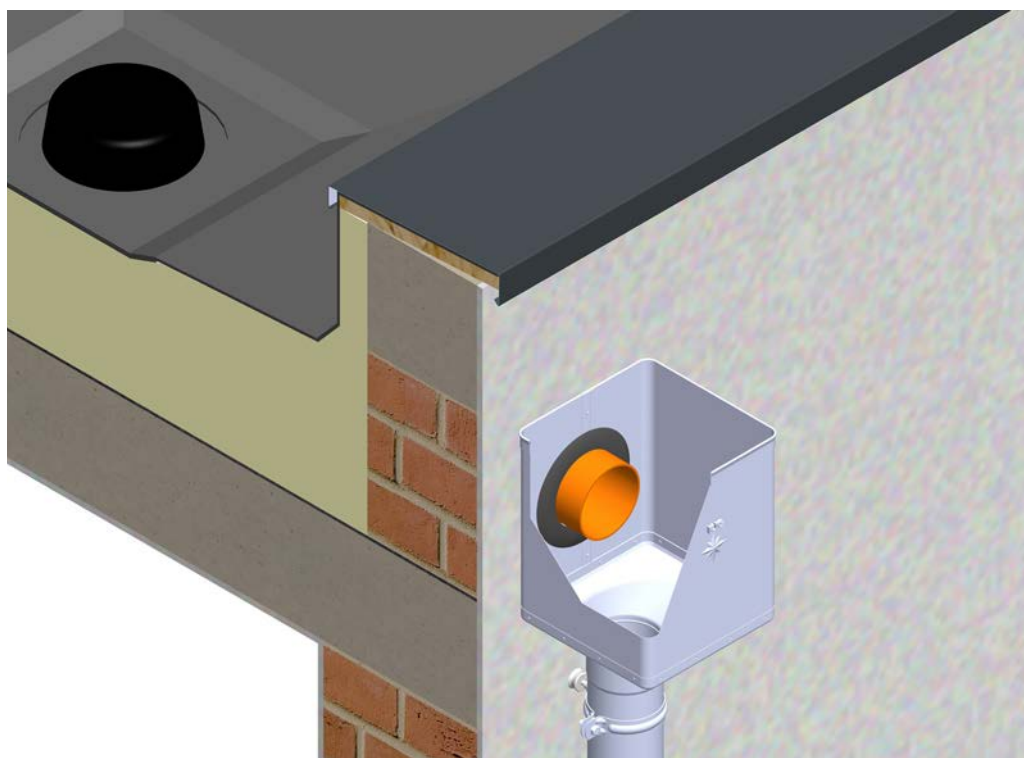

Nominalna veličina	EAN broj narudžbe	Pak. u kom		Cijena [€/kom]	
				Bez PDV	S PDV
IC 70-85	077103	5	600	4,00	5,00
IC 100-110	077110	5	600	4,10	5,13
IC 110-125	077097	5	600	4,20	5,25
PS 70-85	077134	5	600	4,50	5,63
PS 100-110	077141	5	600	4,90	6,13
PS 110-125	077127	5	600	5,00	6,25



KOLJENO 72°

P-PK



Nominalna veličina	60		80		100		120		150	
	Bez PDV	S PDV	Bez PDV	S PDV	Bez PDV	S PDV	Bez PDV	S PDV	Bez PDV	S PDV
TM 1 Testa di Moro RAL 8028	6,00	7,50	5,50	6,88	6,00	7,50	8,50	10,63	19,95	24,94
	072542		072559		072573		072597		033697	
AN 2 Antracit RAL 7016	6,00	7,50	5,50	6,88	6,00	7,50	8,50	10,63	19,95	24,94
	071842		071859		071873		071897		033598	
IC 3 Intenzivno crna RAL 9005	6,00	7,50	5,50	6,88	6,00	7,50	8,50	10,63	19,95	24,94
	071989		072023		072009		072030		033611	
OC 4 Vinsko crvena RAL 3009	6,00	7,50	5,50	6,88	6,00	7,50	8,50	10,63	19,95	24,94
	072337		072344		072368		072382		033666	
MH 5 Bakreno smeđa RAL 8004	6,00	7,50	5,50	6,88	6,00	7,50	8,50	10,63	19,95	24,94
	072054		072061		072085		072108		033628	
SB 6 Sivo bijela RAL 9002	6,00	7,50	5,50	6,88	6,00	7,50	8,50	10,63	19,95	24,94
	072474		072481		072504		072528		033680	
BH 7 Srebrna RAL 9006	6,00	7,50	5,50	6,88	6,00	7,50	8,50	10,63	19,95	24,94
	071910		071927		071941		071965		033604	
PS 8 Prašno siva RAL 7037	6,00	7,50	5,50	6,88	6,00	7,50	8,50	10,63	19,95	24,94
	072405		072412		072429		072443		033673	
MM 9 Metalik bakrena RAL extra	6,00	7,50	5,50	6,88	6,00	7,50	8,50	10,63	19,95	24,94
	072122		072139		072153		072160		033635	
BHT – P.20 10 Tamno srebrna RAL 9007	6,00	7,50	5,50	6,88	6,00	7,50	8,50	10,63	19,95	24,94
	118691 *		095183		095206		095220		095244	
MZ 11 Mahunasto zelena RAL 6005	6,00	7,50	5,50	6,88	6,00	7,50	8,50	10,63	19,95	24,94
	072269		072276		072290		072313		033659	
MOT 12 Tamno plava RAL 5010	6,00	7,50	5,50	6,88	6,00	7,50	8,50	10,63	19,95	24,94
	072191		072207		072221		072245		033642	
TZ 13 Travnato zelena RAL 6011	6,00	7,50	5,50	6,88	6,00	7,50	8,50	10,63	19,95	24,94
	072610 *		072627		072641		072665		033703 *	
Pak. u kom 	25		25		25		15		5	
Pak. u kom 	600		400		300		180		90	

* Proizvodnja po narudžbi



KOLJENO 85°

P-PKR



Nominalna veličina	80		100		120	
	Bez PDV	S PDV	Bez PDV	S PDV	Bez PDV	S PDV
TM 1 Testa di Moro RAL 8028	6,90	8,63	7,80	9,75	12,40	15,50
	072566		072580		072603	
AN 2 Antracit RAL 7016	6,90	8,63	7,80	9,75	12,40	15,50
	071866		071880		071903	
IC 3 Intenzivno crna RAL 9005	6,90	8,63	7,80	9,75	12,40	15,50
	071996		072016		072047	
OC 4 Vinsko crvena RAL 3009	6,90	8,63	7,80	9,75	12,40	15,50
	072351		072375		072399	
MH 5 Bakreno smeđa RAL 8004	6,90	8,63	7,80	9,75	12,40	15,50
	072078		072092		072115	
SB 6 Sivo bijela RAL 9002	6,90	8,63	7,80	9,75	12,40	15,50
	072498		072511		072535	
BH 7 Srebrna RAL 9006	6,90	8,63	7,80	9,75	12,40	15,50
	071934		071958		071972	
PS 8 Prašno siva RAL 7037	6,90	8,63	7,80	9,75	12,40	15,50
	072467		072436		072450	
MM 9 Metalik bakrena RAL extra	6,90	8,63	7,80	9,75	12,40	15,50
	072146		072184		072177	
BHT – P.20 10 Tamno srebrna RAL 9007	6,90	8,63	7,80	9,75	12,40	15,50
	095190		095213		095237 *	
MZ 11 Mahunasto zelena RAL 6005	6,90	8,63	7,80	9,75	12,40	15,50
	072283		072306		072320	
MOT 12 Tamno plava RAL 5010	6,90	8,63	7,80	9,75	12,40	15,50
	072214 *		072238 *		072252 *	
TZ 13 Travnato zelena RAL 6011	6,90	8,63	7,80	9,75	12,40	15,50
	072634 *		072658 *		072672 *	
Pak. u kom 	25		25		15	
Pak. u kom 	400		300		180	

* Proizvodnja po narudžbi



KOLJENO 40°

P-PKT

Nominalna veličina	80		100		120	
	Bez PDV	S PDV	Bez PDV	S PDV	Bez PDV	S PDV
TM 1 Testa di Moro RAL 8028	6,50	8,13	7,10	8,88	10,00	12,50
	072993		073006		073013	
AN 2 Antracit RAL 7016	6,50	8,13	7,10	8,88	10,00	12,50
	072696		072702		072719	
IC 3 Intenzivno crna RAL 9005	6,50	8,13	7,10	8,88	10,00	12,50
	072757		072764		072771	
OC 4 Vinsko crvena RAL 3009	6,50	8,13	7,10	8,88	10,00	12,50
	072900		072917		072924	
MH 5 Bakreno smeđa RAL 8004	6,50	8,13	7,10	8,88	10,00	12,50
	072795		072788		072801	
SB 6 Sivo bijela RAL 9002	6,50	8,13	7,10	8,88	10,00	12,50
	072962		072979		072986	
BH 7 Srebrna RAL 9006	6,50	8,13	7,10	8,88	10,00	12,50
	072726		072733		072740	
PS 8 Prašno siva RAL 7037	6,50	8,13	7,10	8,88	10,00	12,50
	072931		072948		072955	
MM 9 Metalik bakrena RAL extra	6,50	8,13	7,10	8,88	10,00	12,50
	072818		072825		072832 *	
BHT – P.20 10 Tamno srebrna RAL 9007	6,50	8,13	7,10	8,88	10,00	12,50
	094711		094728		094735	
MZ 11 Mahunasto zelena RAL 6005	6,50	8,13	7,10	8,88	10,00	12,50
	072870 *		072887		072894	
MOT 12 Tamno plava RAL 5010	6,50	8,13	7,10	8,88	10,00	12,50
	072849		072856		072863	
TZ 13 Travnato zelena RAL 6011	6,50	8,13	7,10	8,88	10,00	12,50
	073020 *		073037 *		073044 *	
Pak. u kom 	25		25		15	
Pak. u kom 	400		300		240	

* Proizvodnja po narudžbi



KOLJENO ZIGNA 72°

P-PKV



Nominalna veličina	80		100		120	
	Bez PDV	S PDV	Bez PDV	S PDV	Bez PDV	S PDV
TM 1 Testa di Moro RAL 8028	6,50	8,13	7,00	8,75	9,50	11,88
	095046		095053		095060	
AN 2 Antracit RAL 7016	6,50	8,13	7,00	8,75	9,50	11,88
	094742		094759		094766	
IC 3 Intenzivno crna RAL 9005	6,50	8,13	7,00	8,75	9,50	11,88
	094803		094810		094827 *	
OC 4 Vinsko crvena RAL 3009	6,50	8,13	7,00	8,75	9,50	11,88
	094957 *		094964		094971 *	
MH 5 Bakreno smeđa RAL 8004	6,50	8,13	7,00	8,75	9,50	11,88
	094834		094841		094858	
SB 6 Sivo bijela RAL 9002	6,50	8,13	7,00	8,75	9,50	11,88
	095015 *		095022		095039	
BH 7 Srebrna RAL 9006	6,50	8,13	7,00	8,75	9,50	11,88
	094773 *		094780		094797	
PS 8 Prašno siva RAL 7037	6,50	8,13	7,00	8,75	9,50	11,88
	094988 *		094995 *		095008 *	
MM 9 Metalik bakrena RAL extra	6,50	8,13	7,00	8,75	9,50	11,88
	094865 *		094872 *		094889 *	
BHT – P.20 10 Tamno srebrna RAL 9007	6,50	8,13	7,00	8,75	9,50	11,88
	124739 *		124746 *		124753 *	
MZ 11 Mahunasto zelena RAL 6005	6,50	8,13	7,00	8,75	9,50	11,88
	094926 *		094933 *		094940 *	
MOT 12 Tamno plava RAL 5010	6,50	8,13	7,00	8,75	9,50	11,88
	094896 *		094902 *		094919 *	
TZ 13 Travnato zelena RAL 6011	6,50	8,13	7,00	8,75	9,50	11,88
	095077 *		095084 *		095091 *	
Pak. u kom	25		25		15	
Pak. u kom	400		300		180	

* Proizvodnja po narudžbi

KOLJENO FALZANO 72°

P-PKF2



Nominalna veličina	60		80		100		120	
Cijena u €/kom	Bez PDV	S PDV	Bez PDV	S PDV	Bez PDV	S PDV	Bez PDV	S PDV
TM 1 Testa di Moro RAL 8028	4,30	5,38	3,40	4,25	4,40	5,50	6,30	7,88
	071781		071798		071811		071828	
Pak. u kom	10		10		10		8	
Pak. u kom	3 000		1 200		800		576	

KOLJENO FALZANO 85°

P-PKF3



Nominalna veličina	80		100	
Cijena u €/kom	Bez PDV	S PDV	Bez PDV	S PDV
TM 1 Testa di Moro RAL 8028	4,40	5,50	6,30	7,88
	071804		071835	
Pak. u kom	10		10	
Pak. u kom	1 200		800	

PVC IZLJEVNI RUKAV

SD-ZR FOLIA KJG



Nominalna veličina	Dužina u m	EAN broj narudžbe	Pak. u m		Cijena [€/m]	
					Bez PDV	S PDV
60-150	100,0	139726	100	6 000	0,38	0,48

ODVODNA CIJEV [s=0,55]
P-PZR

Nominalna veličina	60		60		80		80		80		
Dužina u m	2,0		3,0		1,0		2,0		3,0		
Cijena u €/m	Bez PDV	S PDV	Bez PDV	S PDV	Bez PDV	S PDV	Bez PDV	S PDV	Bez PDV	S PDV	
TM Testa di Moro RAL 8028	1	8,00	10,00	8,00	10,00	7,20	9,00	7,20	9,00	7,00	8,75
		071309		071316		071323		071330		071347	
AN Antracit RAL 7016	2	8,00	10,00	8,00	10,00	7,20	9,00	7,20	9,00	7,00	8,75
		069467		069474		069481		069498		069504	
IC Intenzivno crna RAL 9005	3	8,00	10,00	8,00	10,00	7,20	9,00	7,20	9,00	7,00	8,75
		069900		069917		069924		069931		069948	
OC Vinsko crvena RAL 3009	4	8,00	10,00	8,00	10,00	7,20	9,00	7,20	9,00	7,00	8,75
		070661		070678		070685		070692		070708	
MH Bakreno smeđa RAL 8004	5	8,10	10,13			7,30	9,13	7,30	9,13	7,10	8,88
		070128				070142		070159		070166	
SB Sivo bijela RAL 9002	6	8,10	10,13	8,10	10,13	7,30	9,13	7,30	9,13	7,10	8,88
		071088		071095		071101		071118		071125	
BH Srebrna RAL 9006	7	8,10	10,13	8,10	10,13	7,30	9,13	7,30	9,13	7,10	8,88
		069689		069696		069702		069719		069726	
PS Prašno siva RAL 7037	8	8,10	10,13	8,10	10,13	7,30	9,13	7,30	9,13	7,10	8,88
		070883		070890		070906		070913		070920	
MM Metalik bakrena RAL extra	9	8,50	10,63			7,75	9,69	7,75	9,69	7,55	9,44
		070340				070364		070371		070388	
BHT – P.20 Tamno srebrna RAL 9007	10									8,55	10,69
										096128	
MZ Mahunasto zelena RAL 6005	11	8,50	10,63							7,55	9,44
		070586								070593	
MOT Tamno plava RAL 5010	12	8,50	10,63							7,55	9,44
		070494								070500	
TZ Travnato zelena RAL 6011	13	8,50	10,63					7,75	9,69		
		071521 *						071538			
Pak. u m 		10		15		10		10		15	
Pak. u m 		490		735		100		250		375	

* Proizvodnja po narudžbi



ODVODNA CIJEV [s=0,55]
P-PZR

Nominalna veličina	80		80		80		100		100		
Dužina u m	4,0		5,0		6,0		1,0		2,0		
Cijena u €/m	Bez PDV	S PDV	Bez PDV	S PDV	Bez PDV	S PDV	Bez PDV	S PDV	Bez PDV	S PDV	
TM Testa di Moro RAL 8028	1	7,00	8,75	7,00	8,75	7,00	8,75	7,40	9,25	7,40	9,25
		071354		071361 *		071378 *		071385		071392	
AN Antracit RAL 7016	2	7,00	8,75	7,00	8,75	7,00	8,75	7,40	9,25	7,40	9,25
		069511		069528 *		069535 *		069542		069559	
IC Intenzivno crna RAL 9005	3	7,00	8,75	7,00	8,75	7,00	8,75	7,40	9,25	7,40	9,25
		069955		069962 *		069979 *		069986		069993	
OC Vinsko crvena RAL 3009	4	7,00	8,75	7,00	8,75	7,00	8,75	7,40	9,25	7,40	9,25
		070715		070722 *		070739 *		070746		070753	
MH Bakreno smeđa RAL 8004	5	7,10	8,88	7,10	8,88	7,10	8,88	7,50	9,38	7,50	9,38
		070173		070180 *		070197 *		070203		070210	
SB Sivo bijela RAL 9002	6	7,10	8,88	7,10	8,88	7,10	8,88	7,50	9,38	7,50	9,38
		071132		071149 *		071156 *		071163		071170	
BH Srebrna RAL 9006	7	7,10	8,88	7,10	8,88	7,10	8,88	7,50	9,38	7,50	9,38
		069733		069740 *		069757 *		069764		069771	
PS Prašno siva RAL 7037	8	7,10	8,88	7,10	8,88	7,10	8,88	7,50	9,38	7,50	9,38
		070937		070944 *		070951 *		070968		070975	
MM Metalik bakrena RAL extra	9	7,55	9,44					8,40	10,50	8,40	10,50
		070395						070401		070418	
BHT – P.20 Tamno srebrna RAL 9007	10										
MZ Mahunasto zelena RAL 6005	11	7,55	9,44								
		070609									
MOT Tamno plava RAL 5010	12										
TZ Travnato zelena RAL 6011	13										
Pak. u m		20		5		6		10		10	
Pak. u m		500		625		750		70		160	

* Proizvodnja po narudžbi



ODVODNA CIJEV [s=0,55]
P-PZR

Nominalna veličina	100		100		100		100		120	
Dužina u m	3,0		4,0		5,0		6,0		1,0	
Cijena u €/m	Bez PDV	S PDV	Bez PDV	S PDV	Bez PDV	S PDV	Bez PDV	S PDV	Bez PDV	S PDV
TM Testa di Moro RAL 8028	7,20	9,00	7,20	9,00	7,20	9,00	7,20	9,00	10,75	13,44
	071408		071415		071422		071439 *		071446	
AN Antracit RAL 7016	7,20	9,00	7,20	9,00	7,20	9,00	7,20	9,00	10,75	13,44
	069566		069573		069580		069597 *		069603	
IC Intenzivno crna RAL 9005	7,20	9,00	7,20	9,00	7,20	9,00	7,20	9,00	10,75	13,44
	070005		070012		070029		070036 *		070043	
OC Vinsko crvena RAL 3009	7,20	9,00	7,20	9,00	7,20	9,00	7,20	9,00	10,75	13,44
	070760		070777		070784 *		070791 *		070807	
MH Bakreno smeđa RAL 8004	7,30	9,13	7,30	9,13	7,30	9,13	7,30	9,13	10,85	13,56
	070227		070234		070241 *		070258 *		070265	
SB Sivo bijela RAL 9002	7,30	9,13	7,30	9,13	7,30	9,13	7,30	9,13	10,85	13,56
	071187		071194		071200 *		071217 *		071224	
BH Srebrna RAL 9006	7,30	9,13	7,30	9,13	7,30	9,13	7,30	9,13	10,85	13,56
	069788		069795		069801 *		069818 *		069825	
PS Prašno siva RAL 7037	7,30	9,13	7,30	9,13	7,30	9,13	7,30	9,13	10,85	13,56
	070982		070999		071002 *		071019 *		071026	
MM Metalik bakrena RAL extra	8,20	10,25	8,20	10,25					11,50	14,38
	070425		070432						070449	
BHT – P.20 Tamno srebrna RAL 9007	8,80	11,00	8,80	11,00						
	096135		096142							
MZ Mahunasto zelena RAL 6005	8,20	10,25	8,20	10,25						
	070616		070623							
MOT Tamno plava RAL 5010	8,20	10,25	8,20	10,25						
	070524		070531							
TZ Travnato zelena RAL 6011	8,20	10,25	8,20	10,25						
	071545		071552							
Pak. u m	15		20		5		6		8	
Pak. u m	240		320		400		480		48	

* Proizvodnja po narudžbi



ODVODNA CIJEV [s=0,55]
P-PZR

Nominalna veličina	120		120		120		120		120	
Dužina u m	2,0		3,0		4,0		5,0		6,0	
Cijena u €/m	Bez PDV	S PDV	Bez PDV	S PDV	Bez PDV	S PDV	Bez PDV	S PDV	Bez PDV	S PDV
TM Testa di Moro RAL 8028	10,75	13,44	10,55	13,19	10,55	13,19	10,55	13,19	10,55	13,19
	071453		071460		071477		071484 *		071491 *	
AN Antracit RAL 7016	10,75	13,44	10,55	13,19	10,55	13,19	10,55	13,19	10,55	13,19
	069610		069627		069634		069641 *		069658 *	
IC Intenzivno crna RAL 9005	10,75	13,44	10,55	13,19	10,55	13,19	10,55	13,19	10,55	13,19
	070050		070067		070074		070081 *		070098 *	
OC Vinsko crvena RAL 3009	10,75	13,44	10,55	13,19	10,55	13,19	10,55	13,19	10,55	13,19
	070814		070821		070838		070845 *		070852 *	
MH Bakreno smeđa RAL 8004	10,85	13,56	10,65	13,31	10,65	13,31	10,65	13,31	10,65	13,31
	070272		070289		070296		070302 *		070319 *	
SB Sivo bijela RAL 9002	10,85	13,56	10,65	13,31	10,65	13,31	10,65	13,31	10,65	13,31
	071231		071248		071255		071262		071279 *	
BH Srebrna RAL 9006	10,85	13,56	10,65	13,31	10,65	13,31	10,65	13,31	10,65	13,31
	069832		069849		069856		069863		069870 *	
PS Prašno siva RAL 7037	10,85	13,56	10,65	13,31	10,65	13,31				
	071033		071040		071057					
MM Metalik bakrena RAL extra	11,50	14,38	11,35	14,19	11,35	14,19				
	070456		070463		070470					
BHT – P.20 Tamno srebrna RAL 9007			12,05	15,06						
			096159							
MZ Mahunasto zelena RAL 6005			11,35	14,19	11,35	14,19				
			070630		070647					
MOT Tamno plava RAL 5010			11,35	14,19	11,35	14,19				
			070548		070555					
TZ Travnato zelena RAL 6011			11,35	14,19	11,35	14,19				
			071569		071576					
Pak. u m	10		15		20		5		6	
Pak. u m	120		180		240		300		360	

* Proizvodnja po narudžbi



ODVODNA CIJEV [s=0,55]
P-PZR

Nominalna veličina	150		150	
Dužina u m	3,0		4,0	
Cijena u €/m	Bez PDV	S PDV	Bez PDV	S PDV
TM 1 Testa di Moro RAL 8028	20,60	25,75	20,60	25,75
	071507		071514	
AN 2 Antracit RAL 7016	20,60	25,75	20,60	25,75
	069665		069672	
IC 3 Intenzivno crna RAL 9005			20,60	25,75
			070111	
OC 4 Vinsko crvena RAL 3009			20,60	25,75
			070876	
MH 5 Bakreno smeđa RAL 8004	20,70	25,88		
	070326			
SB 6 Sivo bijela RAL 9002	20,70	25,88	20,70	25,88
	071286		071293	
BH 7 Srebrna RAL 9006	20,70	25,88	20,70	25,88
	069887		069894	
PS 8 Prašno siva RAL 7037	20,70	25,88	20,70	25,88
	071064		071071	
MM 9 Metalik bakrena RAL extra	21,80	27,25		
	070487			
BHT – P.20 10 Tamno srebrna RAL 9007	22,25	27,81		
	096166			
MZ 11 Mahunasto zelena RAL 6005	21,80	27,25		
	070654			
MOT 12 Tamno plava RAL 5010			21,80	27,25
			070579	
TZ 13 Travnato zelena RAL 6011	21,80	27,25		
	071583 *			
Pak. u m 📦	3		4	
Pak. u m 🚚	84		112	

* Proizvodnja po narudžbi



ODVODNA CIJEV [s=0,50]

P-PZR

Nominalna veličina	80		80		80		80		80	
Dužina u m	1,0		2,0		3,0		4,0		5,0	
Cijena u €/m	Bez PDV	S PDV	Bez PDV	S PDV	Bez PDV	S PDV	Bez PDV	S PDV	Bez PDV	S PDV
TM Testa di Moro RAL 8028	5,95	7,44	5,95	7,44	5,75	7,19	5,75	7,19	5,75	7,19
	068538 *		068545 *		068552		068569 *		068576 *	
AN Antracit RAL 7016	5,95	7,44	5,95	7,44	5,75	7,19	5,75	7,19	5,75	7,19
	067869 *		067876 *		067883		067890 *		067906 *	
IC Intenzivno crna RAL 9005	5,95	7,44	5,95	7,44	5,75	7,19	5,75	7,19	5,75	7,19
	068217 *		068224 *		068231		068248 *		068255 *	
OC Vinsko crvena RAL 3009	5,95	7,44	5,95	7,44	5,75	7,19	5,75	7,19	5,75	7,19
	068378 *		068385 *		068392		068408 *		068415 *	
BH Srebrna RAL 9006	5,95	7,44	5,95	7,44	5,75	7,19	5,75	7,19	5,75	7,19
	068033 *		068040 *		068057 *		068064 *		068071 *	
TH Tamno smeđa ČOKO RAL 8017	5,95	7,44	5,95	7,44	5,75	7,19	5,75	7,19		
	084583 *		084590 *		084606		084613 *			
MH Bakreno smeđa RAL 8004	5,95	7,44	5,95	7,44	5,75	7,19	5,75	7,19	5,75	7,19
	085085 *		085092 *		085108 *		085115 *		085122 *	
Pak. u m	10		10		15		20		5	
Pak. u m	100		250		375		500		625	

* Proizvodnja po narudžbi

ODVODNA CIJEV [s=0,50]

P-PZR

Nominalna veličina	80		100		100		100		100	
Dužina u m	6,0		1,0		2,0		3,0		4,0	
Cijena u €/m	Bez PDV	S PDV	Bez PDV	S PDV	Bez PDV	S PDV	Bez PDV	S PDV	Bez PDV	S PDV
TM Testa di Moro RAL 8028	5,75	7,19	6,50	8,13	6,50	8,13	6,30	7,88	6,30	7,88
	068583 *		068590 *		068606 *		068613		068620 *	
AN Antracit RAL 7016	5,75	7,19	6,50	8,13	6,50	8,13	6,30	7,88	6,30	7,88
	067913 *		067920 *		067937 *		067944		067951 *	
IC Intenzivno crna RAL 9005	5,75	7,19	6,50	8,13	6,50	8,13	6,30	7,88	6,30	7,88
	068262 *		068279 *		068286 *		068293		068309 *	
OC Vinsko crvena RAL 3009	5,75	7,19	6,50	8,13	6,50	8,13	6,30	7,88	6,30	7,88
	068422 *		068439 *		068446 *		068453		068460 *	
BH Srebrna RAL 9006	5,75	7,19	6,50	8,13	6,50	8,13	6,30	7,88	6,30	7,88
	068088 *		068095 *		068101 *		068118 *		068125 *	
TH Tamno smeđa ČOKO RAL 8017			6,50	8,13	6,50	8,13	6,30	7,88	6,30	7,88
			084644 *		084651 *		084668		084675	
MH Bakreno smeđa RAL 8004	5,75	7,19	6,50	8,13	6,50	8,13	6,30	7,88	6,30	7,88
	085139 *		085146 *		085153 *		085160 *		085177 *	
Pak. u m	6		10		10		15		20	
Pak. u m	750		70		160		240		320	

* Proizvodnja po narudžbi

ODVODNA CIJEV [s=0,50]

P-PZR



Nominalna veličina	100		100		120		120		120	
Dužina u m	5,0		6,0		1,0		2,0		3,0	
Cijena u €/m	Bez PDV	S PDV	Bez PDV	S PDV	Bez PDV	S PDV	Bez PDV	S PDV	Bez PDV	S PDV
TM Testa di Moro RAL 8028	6,30	7,88	6,30	7,88	9,20	11,50	9,20	11,50	9,00	11,25
	068637 *		068644 *		068651 *		068668 *		068675	
AN Antracit RAL 7016	6,30	7,88	6,30	7,88	9,20	11,50	9,20	11,50	9,00	11,25
	067968 *		067975 *		067982 *		085023 *		067999	
IC Intenzivno crna RAL 9005	6,30	7,88	6,30	7,88	9,20	11,50	9,20	11,50	9,00	11,25
	068316 *		068323 *		085078 *		084910 *		068330	
OC Vinsko crvena RAL 3009	6,30	7,88	6,30	7,88	9,20	11,50	9,20	11,50	9,00	11,25
	068477 *		068484 *		084927 *		084972 *		068491 *	
BH Srebrna RAL 9006	6,30	7,88	6,30	7,88	9,20	11,50	9,20	11,50	9,00	11,25
	068132 *		068149 *		068156 *		068163 *		068170 *	
TH Tamno smeđa ČOKO RAL 8017					9,20	11,50	9,20	11,50	9,00	11,25
					084705 *		084712 *		084729 *	
MH Bakreno smeđa RAL 8004	6,30	7,88	6,30	7,88	9,20	11,50	9,20	11,50	9,00	11,25
	085184 *		085191 *		085207 *		085214 *		085221 *	
Pak. u m	5		6		8		10		15	
Pak. u m	400		480		48		120		180	

* Proizvodnja po narudžbi

ODVODNA CIJEV [s=0,50]

P-PZR





Nominalna veličina	120		120		120	
Dužina u m	4,0		5,0		6,0	
Cijena u €/m	Bez PDV	S PDV	Bez PDV	S PDV	Bez PDV	S PDV
TM Testa di Moro RAL 8028	9,00	11,25	9,00	11,25	9,00	11,25
	068682 *		068699 *		068705 *	
AN Antracit RAL 7016	9,00	11,25	9,00	11,25	9,00	11,25
	068002 *		068019 *		068026 *	
IC Intenzivno crna RAL 9005	9,00	11,25	9,00	11,25	9,00	11,25
	068347 *		068354 *		068361 *	
OC Vinsko crvena RAL 3009	9,00	11,25	9,00	11,25	9,00	11,25
	068507 *		068514 *		068521 *	
BH Srebrna RAL 9006	9,00	11,25	9,00	11,25	9,00	11,25
	068187 *		068194 *		068200 *	
TH Tamno smeđa ČOKO RAL 8017	9,00	11,25				
	084736 *					
MH Bakreno smeđa RAL 8004	9,00	11,25	9,00	11,25	9,00	11,25
	085238 *		085245 *		085252 *	
Pak. u m	20		5		6	
Pak. u m	240		300		360	

* Proizvodnja po narudžbi

SPOJKA CIJEVI

P-PSRU

Nominalna veličina	80		100		120	
	Bez PDV	S PDV	Bez PDV	S PDV	Bez PDV	S PDV
TM 1 Testa di Moro RAL 8028	4,25	5,31	4,40	5,50	4,90	6,13
	017581		017598		017604	
AN 2 Antracit RAL 7016	4,25	5,31	4,40	5,50	4,90	6,13
	017284		017291		017307	
IC 3 Intenzivno crna RAL 9005	4,25	5,31	4,40	5,50	4,90	6,13
	017345		017352		017369	
OC 4 Vinsko crvena RAL 3009	4,25	5,31	4,40	5,50	4,90	6,13
	017499		017505		017512	
MH 5 Bakreno smeđa RAL 8004	4,25	5,31	4,40	5,50	4,90	6,13
	017376		017383		017390	
SB 6 Sivo bijela RAL 9002	4,25	5,31	4,40	5,50	4,90	6,13
	017550		017567		017574	
BH 7 Srebrna RAL 9006	4,25	5,31	4,40	5,50	4,90	6,13
	017314		017321		017338	
PS 8 Prašno siva RAL 7037	4,25	5,31	4,40	5,50	4,90	6,13
	017529		017536		017543	
MM 9 Metalik bakrena RAL extra	4,25	5,31	4,40	5,50	4,90	6,13
	017406		017413		017420	
BHT – P.20 10 Tamno srebrna RAL 9007	4,25	5,31	4,40	5,50	4,90	6,13
	095657 *		095664		095671 *	
MZ 11 Mahunasto zelena RAL 6005	4,25	5,31	4,40	5,50	4,90	6,13
	017468 *		017475		017482	
MOT 12 Tamno plava RAL 5010	4,25	5,31	4,40	5,50	4,90	6,13
	017437 *		017444		017451	
TZ 13 Travnato zelena RAL 6011	4,25	5,31	4,40	5,50	4,90	6,13
	017611 *		017628		017635 *	
Pak. u kom 	10		10		8	
Pak. u kom 	900		900		720	

* Proizvodnja po narudžbi



KOLJENO ODSKOČNO

P-PKO



Nominalna veličina	80		100		120	
	Bez PDV	S PDV	Bez PDV	S PDV	Bez PDV	S PDV
TM 1 Testa di Moro RAL 8028	9,40	11,75	9,70	12,13	13,95	17,44
	034045		034052		034069	
AN 2 Antracit RAL 7016	9,40	11,75	9,70	12,13	13,95	17,44
	033741		033758		033765	
IC 3 Intenzivno crna RAL 9005	9,40	11,75	9,70	12,13	13,95	17,44
	033802		033819		033826	
OC 4 Vinsko crvena RAL 3009	9,40	11,75	9,70	12,13	13,95	17,44
	033956		033963		033970	
MH 5 Bakreno smeđa RAL 8004	9,40	11,75	9,70	12,13	13,95	17,44
	033833		033840		033857	
SB 6 Sivo bijela RAL 9002	9,40	11,75	9,70	12,13	13,95	17,44
	034014		034021		034038	
BH 7 Srebrna RAL 9006	9,40	11,75	9,70	12,13	13,95	17,44
	033772		033789		033796	
PS 8 Prašno siva RAL 7037	9,40	11,75	9,70	12,13	13,95	17,44
	033987		033994		034007	
MM 9 Metalik bakrena RAL extra	9,40	11,75	9,70	12,13	13,95	17,44
	033864		033871		033888	
BHT – P.20 10 Tamno srebrna RAL 9007	9,40	11,75	9,70	12,13	13,95	17,44
	095688		095695		095701	
MZ 11 Mahunasto zelena RAL 6005	9,40	11,75	9,70	12,13	13,95	17,44
	033925		033932		033949	
MOT 12 Tamno plava RAL 5010	9,40	11,75	9,70	12,13	13,95	17,44
	033895		033901		033918	
TZ 13 Travnato zelena RAL 6011	9,40	11,75	9,70	12,13	13,95	17,44
	034076		034083		034090	
Pak. u kom	20		20		15	
Pak. u kom	320		240		180	

REDUKCIJA CIJEVI 72°

P-PZO

Nominalna veličina	80/80		100/60		100/80		100/100	
	Bez PDV	S PDV	Bez PDV	S PDV	Bez PDV	S PDV	Bez PDV	S PDV
TM 1 Testa di Moro RAL 8028	15,65	19,56	17,40	21,75	17,40	21,75	18,00	22,50
	016157		016164		016171		016188	
AN 2 Antracit RAL 7016	15,65	19,56	17,40	21,75	17,40	21,75	18,00	22,50
	015259		015266		015273		015280	
IC 3 Intenzivno crna RAL 9005	15,65	19,56	17,40	21,75	17,40	21,75	18,00	22,50
	015433		015440		015457		015464	
OC 4 Vinsko crvena RAL 3009	15,65	19,56	17,40	21,75	17,40	21,75	18,00	22,50
	015884		015891		015907		015914	
MH 5 Bakreno smeđa RAL 8004	15,65	19,56	17,40	21,75	17,40	21,75	18,00	22,50
	015525		015532 *		015549		015556	
SB 6 Sivo bijela RAL 9002	15,65	19,56	17,40	21,75	17,40	21,75	18,00	22,50
	016065		016072 *		016089		016096	
BH 7 Srebrna RAL 9006	15,65	19,56	17,40	21,75	17,40	21,75	18,00	22,50
	015341		015358 *		015365		015372	
PS 8 Prašno siva RAL 7037	15,65	19,56	17,40	21,75	17,40	21,75	18,00	22,50
	015976 *		015983 *		015990		016003	
MM 9 Metalik bakrena RAL extra	15,65	19,56	17,40	21,75	17,40	21,75	18,00	22,50
	015617		015624 *		015631		015648	
BHT – P.20 10 Tamno srebrna RAL 9007	15,65	19,56			17,40	21,75	18,00	22,50
	096005 *				096012 *		096029 *	
MZ 11 Mahunasto zelena RAL 6005	15,65	19,56	17,40	21,75	17,40	21,75	18,00	22,50
	015792		015808 *		015815		015822	
MOT 12 Tamno plava RAL 5010	15,65	19,56	17,40	21,75	17,40	21,75	18,00	22,50
	015709 *		015716 *		015723 *		015730	
TZ 13 Travnato zelena RAL 6011	15,65	19,56	17,40	21,75	17,40	21,75	18,00	22,50
	016249 *		016256 *		016263 *		016270 *	
Pak. u kom 	4		4		4		4	
Pak. u kom 	120		120		120		120	

* Proizvodnja po narudžbi



REDUKCIJA CIJEVI 72°

P-PZO



Nominalna veličina	120/80		120/100		120/120		150/120		150/150	
	Bez PDV	S PDV	Bez PDV	S PDV	Bez PDV	S PDV	Bez PDV	S PDV	Bez PDV	S PDV
TM 1 Testa di Moro RAL 8028	19,80	24,75	19,80	24,75	19,80	24,75	28,80	36,00	28,80	36,00
	016195		016201		016218		016225 *		016232 *	
AN 2 Antracit RAL 7016	19,80	24,75	19,80	24,75	19,80	24,75	28,80	36,00	28,80	36,00
	015297		015303		015310		015327 *		015334 *	
IC 3 Intenzivno crna RAL 9005	19,80	24,75	19,80	24,75	19,80	24,75	28,80	36,00	28,80	36,00
	015471		015488		015495		015501 *		015518 *	
OC 4 Vinsko crvena RAL 3009	19,80	24,75	19,80	24,75	19,80	24,75	28,80	36,00	28,80	36,00
	015921		015938		015945		015952 *		015969 *	
MH 5 Bakreno smeđa RAL 8004	19,80	24,75	19,80	24,75	19,80	24,75	28,80	36,00	28,80	36,00
	015563		015570		015587		015594 *		015600 *	
SB 6 Sivo bijela RAL 9002	19,80	24,75	19,80	24,75	19,80	24,75	28,80	36,00	28,80	36,00
	016102		016119		016126		016133 *		016140 *	
BH 7 Srebrna RAL 9006	19,80	24,75	19,80	24,75	19,80	24,75	28,80	36,00	28,80	36,00
	015389		015396		015402		015419 *		015426 *	
PS 8 Prašno siva RAL 7037	19,80	24,75	19,80	24,75	19,80	24,75	28,80	36,00	28,80	36,00
	016010 *		016027		016034		016041 *		016058 *	
MM 9 Metalik bakrena RAL extra	19,80	24,75	19,80	24,75	19,80	24,75	28,80	36,00	28,80	36,00
	015655 *		015662		015679		015686 *		015693 *	
BHT – P.20 10 Tamno srebrna RAL 9007	19,80	24,75	19,80	24,75	19,80	24,75				
	096036 *		096043 *		096050 *					
MZ 11 Mahunasto zelena RAL 6005	19,80	24,75	19,80	24,75	19,80	24,75	28,80	36,00	28,80	36,00
	015839 *		015846 *		015853 *		015860 *		015877 *	
MOT 12 Tamno plava RAL 5010	19,80	24,75	19,80	24,75	19,80	24,75	28,80	36,00	28,80	36,00
	015747 *		015754 *		015761 *		015778 *		015785 *	
TZ 13 Travnato zelena RAL 6011	19,80	24,75	19,80	24,75	19,80	24,75	28,80	36,00	28,80	36,00
	016287 *		016294 *		016300 *		016317 *		016324 *	
Pak. u kom	3		3		3		2		2	
Pak. u kom	90		90		90		36		36	

* Proizvodnja po narudžbi

RAZDJELNIK VODE

P-PRV

Nominalna veličina	80		100		120	
	Bez PDV	S PDV	Bez PDV	S PDV	Bez PDV	S PDV
TM 1 Testa di Moro RAL 8028	195,00	243,75	199,90	249,88	259,00	323,75
	088413 *		088420		088437 *	
AN 2 Antracit RAL 7016	195,00	243,75	199,90	249,88	259,00	323,75
	088116 *		088123		088130 *	
IC 3 Intenzivno crna RAL 9005	195,00	243,75	199,90	249,88	259,00	323,75
	088178 *		088185 *		088192 *	
OC 4 Vinsko crvena RAL 3009	195,00	243,75	199,90	249,88	259,00	323,75
	088321 *		088338 *		088345 *	
MH 5 Bakreno smeđa RAL 8004	195,00	243,75	199,90	249,88	259,00	323,75
	088208 *		088215 *		088222 *	
SB 6 Sivo bijela RAL 9002	195,00	243,75	199,90	249,88	259,00	323,75
	088383 *		088390 *		088406 *	
BH 7 Srebrna RAL 9006	195,00	243,75	199,90	249,88	259,00	323,75
	088147 *		088154 *		088161 *	
PS 8 Prašno siva RAL 7037	195,00	243,75	199,90	249,88	259,00	323,75
	088352 *		088369 *		088376 *	
MM 9 Metalik bakrena RAL extra	195,00	243,75	199,90	249,88	259,00	323,75
	088239 *		088246 *		088253 *	
BHT – P.20 10 Tamno srebrna RAL 9007	195,00	243,75	199,90	249,88	259,00	323,75
	095756 *		095763 *		095770 *	
MZ 11 Mahunasto zelena RAL 6005	195,00	243,75	199,90	249,88	259,00	323,75
	088291 *		088307 *		088314 *	
MOT 12 Tamno plava RAL 5010	195,00	243,75	199,90	249,88	259,00	323,75
	088260 *		088277 *		088284 *	
TZ 13 Travnato zelena RAL 6011	195,00	243,75	199,90	249,88	259,00	323,75
	088444 *		088451 *		088468 *	
Pak. u kom 		1		1		1
Pak. u kom 		–		–		–

* Proizvodnja po narudžbi



OBUJMICA TRN 150 mm

P-PO

Nominalna veličina	80		100		120	
	Bez PDV	S PDV	Bez PDV	S PDV	Bez PDV	S PDV
TM 1 Testa di Moro RAL 8028	3,30	4,13	3,35	4,19	4,00	5,00
	002136		002143		002150	
AN 2 Antracit RAL 7016	3,30	4,13	3,35	4,19	4,00	5,00
	001986		001993		002006	
IC 3 Intenzivno crna RAL 9005	3,30	4,13	3,35	4,19	4,00	5,00
	002013		002020		002037	
OC 4 Vinsko crvena RAL 3009	3,30	4,13	3,35	4,19	4,00	5,00
	002075		002082		002099	
MH 5 Bakreno smeđa RAL 8004	3,30	4,13	3,35	4,19	4,00	5,00
	002044		002051		002068	
SB 6 Sivo bijela RAL 9002	3,30	4,13	3,35	4,19	4,00	5,00
	002105		002112		002129	
Pak. u kom 📦	25		25		25	
Pak. u kom 🚚	1 000		1 000		1 000	



OBUJMICA TRN 200 mm



P-POD

Nominalna veličina	80		100		120	
	Bez PDV	S PDV	Bez PDV	S PDV	Bez PDV	S PDV
TM 1 Testa di Moro RAL 8028	3,50	4,38	3,50	4,38	4,05	5,06
	001955		001962		001979	
AN 2 Antracit RAL 7016	3,50	4,38	3,50	4,38	4,05	5,06
	001801		001818		001825	
IC 3 Intenzivno crna RAL 9005	3,50	4,38	3,50	4,38	4,05	5,06
	001832		001849		001856	
OC 4 Vinsko crvena RAL 3009	3,50	4,38	3,50	4,38	4,05	5,06
	001894		001900		001917	
MH 5 Bakreno smeđa RAL 8004	3,50	4,38	3,50	4,38	4,05	5,06
	001863		001870		001887	
SB 6 Sivo bijela RAL 9002	3,50	4,38	3,50	4,38	4,05	5,06
	001924		001931		001948	
Pak. u kom 📦	25		25		25	
Pak. u kom 🚚	1 000		1 000		1 000	



OBUJMICA TRN 300 mm



P-PODD

Nominalna veličina	100		120	
	Bez PDV	S PDV	Bez PDV	S PDV
TM 1 Testa di Moro RAL 8028	4,55	5,69	4,95	6,19
	002402		002419	
AN 2 Antracit RAL 7016	4,55	5,69	4,95	6,19
	002303		002310	
IC 3 Intenzivno crna RAL 9005	4,55	5,69	4,95	6,19
	002327		002334	
OC 4 Vinsko crvena RAL 3009	4,55	5,69	4,95	6,19
	002365		002372	
MH 5 Bakreno smeđa RAL 8004	4,55	5,69	4,95	6,19
	002341		002358	
SB 6 Sivo bijela RAL 9002	4,55	5,69	4,95	6,19
	002389		002396	
Pak. u kom  7	20		20	
Pak. u kom 	800		800	



OBUJMICA S NAVOJEM M10

P-POB

Nominalna veličina	60		80		100		120		150	
	Bez PDV	S PDV	Bez PDV	S PDV	Bez PDV	S PDV	Bez PDV	S PDV	Bez PDV	S PDV
TM 1 Testa di Moro RAL 8028	2,90	3,63	2,65	3,31	2,75	3,44	3,30	4,13	4,90	6,13
	074119		074126		074133		074140		074157	
AN 2 Antracit RAL 7016	2,90	3,63	2,65	3,31	2,75	3,44	3,30	4,13	4,90	6,13
	073471		073488		073495		073501		073518	
IC 3 Intenzivno crna RAL 9005	2,90	3,63	2,65	3,31	2,75	3,44	3,30	4,13	4,90	6,13
	073679		073686		073693		073709		073716	
OC 4 Vinsko crvena RAL 3009	2,90	3,63	2,65	3,31	2,75	3,44	3,30	4,13	4,90	6,13
	073914		073921		073938		073945		073952	
MH 5 Bakreno smeđa RAL 8004	2,90	3,63	2,65	3,31	2,75	3,44	3,30	4,13	4,90	6,13
	073723		073730		073747		073754		073761	
SB 6 Sivo bijela RAL 9002	2,90	3,63	2,65	3,31	2,75	3,44	3,30	4,13	4,90	6,13
	074010		074027		074034		074041		074058	
BH 7 Srebrna RAL 9006	2,90	3,63	2,65	3,31	2,75	3,44	3,30	4,13	4,90	6,13
	073570		073587		073594		073600		073617	
PS 8 Prašno siva RAL 7037	2,90	3,63	2,65	3,31	2,75	3,44	3,30	4,13	4,90	6,13
	073969		073976		073983		073990		074003	
MM 9 Metalik bakrena RAL extra	2,90	3,63	2,65	3,31	2,75	3,44	3,30	4,13	4,90	6,13
	073778		073785		073792		073808		077158	
BHT – P.20 10 Tamno srebrna RAL 9007	2,90	3,63	2,65	3,31	2,75	3,44	3,30	4,13	4,90	6,13
	119711		094537		094544		094551		094674	
MZ 11 Mahunasto zelena RAL 6005	2,90	3,63	2,65	3,31	2,75	3,44	3,30	4,13	4,90	6,13
	073860		073877		073884		073891		073907	
MOT 12 Tamno plava RAL 5010	2,90	3,63	2,65	3,31	2,75	3,44	3,30	4,13	4,90	6,13
	073815		073822		073839		073846		073853	
TZ 13 Travnato zelena RAL 6011	2,90	3,63	2,65	3,31	2,75	3,44	3,30	4,13	4,90	6,13
	074164 *		074171		074188		074195		074201 *	
Pak. u kom 	25		25		25		25		20	
Pak. u kom 	3 000		3 000		3 000		3 000		2 400	

* Proizvodnja po narudžbi



OBUJMICA S NAVOJEM M8

P-POB





Nominalna veličina	60		80		100		120		150	
Cijena u €/kom	Bez PDV	S PDV	Bez PDV	S PDV	Bez PDV	S PDV	Bez PDV	S PDV	Bez PDV	S PDV
TM 1 Testa di Moro RAL 8028	2,90	3,63	2,65	3,31	2,75	3,44	3,30	4,13	4,90	6,13
	074065		074072		074089		074096		074102	
AN 2 Antracit RAL 7016	2,90	3,63	2,65	3,31	2,75	3,44	3,30	4,13	4,90	6,13
	073426		073433		073440		073457		073464	
IC 3 Intenzivno crna RAL 9005	2,90	3,63	2,65	3,31	2,75	3,44	3,30	4,13	4,90	6,13
	073624		073631		073648		073655		073662	
BH 7 Srebrna RAL 9006	2,90	3,63	2,65	3,31	2,75	3,44	3,30	4,13	4,90	6,13
	073532		073525		073549		073556		073563	
Pak. u kom 📦	25		25		25		25		20	
Pak. u kom 🛒	3 000		3 000		3 000		3 000		2 400	



VIJAK ZA OBUJMICU M6x20

P-POB-NSK





Nominalna veličina	EAN broj narudžbe	Pak. u kom		Cijena [€/kom]	
				Bez PDV	S PDV
M6 x 20 *	071675	1	–	0,15	0,19

* Proizvodnja po narudžbi

VIJAK ZA OBUJMICU TORX M10

P-POB-HT





Nominalna veličina	EAN broj narudžbe	Pak. u kom		Cijena [€/kom]	
				Bez PDV	S PDV
80	002464	100	40 000	1,00	1,25
140	002471	100	28 000	1,25	1,56
200	002488	100	20 000	1,55	1,94
250	002495	100	16 000	1,70	2,13
300	002501	100	11 200	1,70	2,13

TIPLA M10

P-POB-HN DB





Nominalna veličina	EAN broj narudžbe	Pak. u kom		Cijena [€/kom]	
				Bez PDV	S PDV
120	002426	100	25 000	0,40	0,50

TIPLA S LAMELOM M10

P-POB-HN DB





Nominalna veličina	EAN broj narudžbe	Pak. u kom		Cijena [€/kom]	
				Bez PDV	S PDV
180	002433	100	12 000	0,42	0,53
240	002440	100	12 000	0,50	0,63
280	002457	100	12 000	0,53	0,66

KOMBINIRANI VIJAK TORX M10

P-POB-ZT/SZ



Nominalna veličina	EAN broj narudžbe	Pak. u kom		Cijena [€/kom]	
				Bez PDV	S PDV
140	002587	50	10 400	0,45	0,56
180	002594	50	10 400	0,55	0,69

TIPLA KVADRATNA ŠPICA 7x7

P-POB-HN R1



Nominalna veličina	EAN broj narudžbe	Pak. u kom		Cijena [€/kom]	
				Bez PDV	S PDV
200/60	002600	250	15 000	0,17	0,21

TIPLA ZA IZOLACIJU M10

P-POB-HN IZOL



Nominalna veličina	EAN broj narudžbe	Pak. u kom		Cijena [€/kom]	
				Bez PDV	S PDV
M10 x 96	001207	25	2 625	2,95	3,69

KLIN SA PVC TIPLOM ZA OPEKU BEZ IZOLACIJE

P-POB-HN WDVS140 M10



Nominalna veličina	EAN broj narudžbe	Pakiranje u kom		Cijena [€/kom]	
				Bez PDV	S PDV
140	144843	1/5	750	4,80	6,00

KLIN SA PVC TIPLOM ZA OPEKU SA IZOLACIJOM

P-POB-HN WDVS300 M10



Nominalna veličina	EAN broj narudžbe	Pakiranje u kom		Cijena [€/kom]	
				Bez PDV	S PDV
300	144850	1/5	500	7,80	9,75

UNI NASTAVAK OD NEHRĐAJUČEG ČELIKA ZA PRIČVRŠČIVANJE OB M10

P-POB-HN PLAT M10



Nominalna veličina	EAN broj narudžbe	Pakiranje u kom		Cijena [€/kom]	
				Bez PDV	S PDV
M10	144836	25/500	5 000	3,35	4,19

NAVOJNA ŠIPKA M10

P-POB-ZT



Nominalna veličina	EAN broj narudžbe	Pak. u kom		Cijena [€/kom]	
				Bez PDV	S PDV
60	002556	100	20 800	0,20	0,25
100	002563	100	15 600	0,30	0,38
150	002570	50	10 400	0,55	0,69

MONTAŽNA PLOČICA M10

P-POB-ZT MP



Nominalna veličina	EAN broj narudžbe	Pak. u kom		Cijena [€/kom]	
				Bez PDV	S PDV
80 x 30	002518	25	5 200	1,15	1,44

VIJAK ZA OBUJMICU M8

P-POB-HB



Nominalna veličina	EAN broj narudžbe	Pak. u kom		Cijena [€/kom]	
				Bez PDV	S PDV
150	071590	100	5 000	0,65	0,81
200	071606	100	5 000	0,92	1,15
250	071613	100	5 000	1,05	1,31
300	071620	100	5 000	1,10	1,38

TIPLA M8

P-POB-HBN-SS



Nominalna veličina	EAN broj narudžbe	Pak. u kom		Cijena [€/kom]	
				Bez PDV	S PDV
150	071637	100	5 000	0,25	0,31
200	071644	100	5 000	0,26	0,33
250	071651	100	5 000	0,35	0,44
300	071668	100	8 000	0,37	0,46

ZAŠTITNI POKLOPAC OBUJMIC

P-POB-HT AKG



Nominalna veličina	EAN broj narudžbe	Pak. u kom		Cijena [€/kom]	
				Bez PDV	S PDV
29 x 13	002280	50	16 800	0,25	0,31
29 x 13	002211	50	16 800	0,25	0,31
29 x 13	002235	50	16 800	0,25	0,31
29 x 13	002266	50	16 800	0,25	0,31
29 x 13	002242	50	16 800	0,25	0,31
29 x 13	002228	50	16 800	0,25	0,31
29 x 13	002273	50	16 800	0,25	0,31
29 x 13	002259	50	16 800	0,25	0,31
29 x 13	002297	50	16 800	0,25	0,31

ZADRŽAČ VODE

P-PZV



Nominalna veličina	80		100		120	
	Bez PDV	S PDV	Bez PDV	S PDV	Bez PDV	S PDV
TM 1 Testa di Moro RAL 8028	12,55	15,69	12,95	16,19	19,00	23,75
	034533		034540		034557	
AN 2 Antracit RAL 7016	12,55	15,69	12,95	16,19	19,00	23,75
	034410		034427		034434	
IC 3 Intenzivno crna RAL 9005	12,55	15,69	12,95	16,19	19,00	23,75
	034441		034458		034465	
OC 4 Vinsko crvena RAL 3009	12,55	15,69	12,95	16,19	19,00	23,75
	034502		034519		034526	
MH 5 Bakreno smeđa RAL 8004	12,55	15,69	12,95	16,19	19,00	23,75
	034472		034489		034496	
Pak. u kom	6		5		3	
Pak. u kom	180		150		90	

ZADRŽAČ VODE SA SITOM

P-PZVS





Nominalna veličina	80		100		120	
	Bez PDV	S PDV	Bez PDV	S PDV	Bez PDV	S PDV
TM 1 Testa di Moro RAL 8028	12,55	15,69	12,95	16,19	19,00	23,75
	034861		034878		034885	
AN 2 Antracit RAL 7016	12,55	15,69	12,95	16,19	19,00	23,75
	034564		034571		034588	
IC 3 Intenzivno crna RAL 9005	12,55	15,69	12,95	16,19	19,00	23,75
	034625		034632		034649	
OC 4 Vinsko crvena RAL 3009	12,55	15,69	12,95	16,19	19,00	23,75
	034779		034786		034793	
MH 5 Bakreno smeđa RAL 8004	12,55	15,69	12,95	16,19	19,00	23,75
	034656		034663		034670	
SB 6 Sivo bijela RAL 9002	12,55	15,69	12,95	16,19	19,00	23,75
	034830		034847		034854	
BH 7 Srebrna RAL 9006	12,55	15,69	12,95	16,19	19,00	23,75
	034595		034601		034618	
PS 8 Prašno siva RAL 7037	12,55	15,69	12,95	16,19	19,00	23,75
	034809		034816		034823	
MM 9 Metalik bakrena RAL extra	12,55	15,69	12,95	16,19	19,00	23,75
	034687		034694		034700	
BHT – P.20 10 Tamno srebrna RAL 9007	12,55	15,69	12,95	16,19	19,00	23,75
	095718		095725		095732	
MZ 11 Mahunasto zelena RAL 6005	12,55	15,69	12,95	16,19	19,00	23,75
	034748		034755		034762	
MOT 12 Tamno plava RAL 5010	12,55	15,69	12,95	16,19	19,00	23,75
	034717		034724		034731	
TZ 13 Travnato zelena RAL 6011	12,55	15,69	12,95	16,19	19,00	23,75
	034892 *		034908		034915	
Pak. u kom	6		5		3	
Pak. u kom	180		150		90	

* Proizvodnja po narudžbi

ALUMINIJSKI ZADRŽAČ VODE SA CRIJEVOM

P-PZVHA

Nominalna veličina	80		100		120	
	Bez PDV	S PDV	Bez PDV	S PDV	Bez PDV	S PDV
TM 1 Testa di Moro RAL 8028	65,00	81,25	65,00	81,25	133,50	166,88
	018793		018809		018816	
AN 2 Antracit RAL 7016	65,00	81,25	65,00	81,25	133,50	166,88
	018496		018502		018519	
IC 3 Intenzivno crna RAL 9005	65,00	81,25	65,00	81,25	133,50	166,88
	018557		018564		018571	
OC 4 Vinsko crvena RAL 3009	65,00	81,25	65,00	81,25	133,50	166,88
	018700		018717		018724 *	
MH 5 Bakreno smeđa RAL 8004	65,00	81,25	65,00	81,25	133,50	166,88
	018588 *		018595		018601 *	
SB 6 Sivo bijela RAL 9002	65,00	81,25	65,00	81,25	133,50	166,88
	018762 *		018779		018786	
BH 7 Srebrna RAL 9006	65,00	81,25	65,00	81,25	133,50	166,88
	018526		018533		018540	
PS 8 Prašno siva RAL 7037	65,00	81,25	65,00	81,25	133,50	166,88
	018731 *		018748		018755 *	
MM 9 Metalik bakrena RAL extra	65,00	81,25	65,00	81,25	133,50	166,88
	018618 *		018625 *		018632 *	
BHT – P.20 10 Tamno srebrna RAL 9007	65,00	81,25	65,00	81,25	133,50	166,88
	095527 *		095534 *		095541 *	
MZ 11 Mahunasto zelena RAL 6005	65,00	81,25	65,00	81,25	133,50	166,88
	018670 *		018687		018694 *	
MOT 12 Tamno plava RAL 5010	65,00	81,25	65,00	81,25	133,50	166,88
	018649 *		018656 *		018663 *	
TZ 13 Travnato zelena RAL 6011	65,00	81,25	65,00	81,25	133,50	166,88
	018823 *		018830 *		018847 *	
Pak. u kom 	1		1		1	
Pak. u kom 	60		60		60	

* Proizvodnja po narudžbi



ZAŠTITNA CIJEV S REV. OB

P-POZR



Nominalna veličina	80		100		100	
Dužina u m	1,0		1,0		1,5	
Cijena u €/m	Bez PDV	S PDV	Bez PDV	S PDV	Bez PDV	S PDV
TM 1 Testa di Moro RAL 8028	64,00	80,00	49,00	61,25	97,00	121,25
	010254 *		010261		010278	
AN 2 Antracit RAL 7016	64,00	80,00	49,00	61,25	97,00	121,25
	009760 *		009777		009784 *	
IC 3 Intenzivno crna RAL 9005	64,00	80,00	49,00	61,25	97,00	121,25
	009869 *		009876		009883 *	
OC 4 Vinsko crvena RAL 3009	64,00	80,00	49,00	61,25	97,00	121,25
	010117 *		010124 *		010131 *	
MH 5 Bakreno smeđa RAL 8004	64,00	80,00	49,00	61,25	97,00	121,25
	009913 *		009920 *		009937 *	
SB 6 Sivo bijela RAL 9002	64,00	80,00	49,00	61,25	97,00	121,25
	010209 *		010247 *		010216 *	
BH 7 Srebrna RAL 9006	64,00	80,00	49,00	61,25	97,00	121,25
	009814 *		009821 *		009838 *	
PS 8 Prašno siva RAL 7037	64,00	80,00	49,00	61,25	97,00	121,25
	010162 *		010179 *		010186 *	
MM 9 Metalik bakrena RAL extra	64,00	80,00	49,00	61,25	97,00	121,25
	009968 *		009975 *		009982 *	
BHT – P.20 10 Tamno srebrna RAL 9007	64,00	80,00	49,00	61,25		
	096494 *		096500 *			
MZ 11 Mahunasto zelena RAL 6005	64,00	80,00	49,00	61,25	97,00	121,25
	010063 *		010070 *		010087 *	
MOT 12 Tamno plava RAL 5010	64,00	80,00	49,00	61,25	97,00	121,25
	010018 *		010025 *		010032 *	
TZ 13 Travnato zelena RAL 6011	64,00	80,00	49,00	61,25	97,00	121,25
	010308 *		010315 *		010322 *	
Pak. u kom	1		1		1	
Pak. u kom	70		60		60	

* Proizvodnja po narudžbi

POCINK POLYESTER

ZAŠTITNA CIJEV S REV. OB



P-POZR

Nominalna veličina	120		120	
	1,0		1,5	
Dužina u m	1,0		1,5	
Cijena u €/m	Bez PDV	S PDV	Bez PDV	S PDV
TM 1 Testa di Moro RAL 8028	115,00	143,75	165,00	206,25
	010285		010292 *	
AN 2 Antracit RAL 7016	115,00	143,75	165,00	206,25
	009791 *		009807 *	
IC 3 Intenzivno crna RAL 9005	115,00	143,75	165,00	206,25
	009890 *		009906 *	
OC 4 Vinsko crvena RAL 3009	115,00	143,75	165,00	206,25
	010148 *		010155 *	
MH 5 Bakreno smeđa RAL 8004	115,00	143,75	165,00	206,25
	009944 *		009951 *	
SB 6 Sivo bijela RAL 9002	115,00	143,75	165,00	206,25
	010223 *		010230 *	
BH 7 Srebrna RAL 9006	115,00	143,75	165,00	206,25
	009845 *		009852 *	
PS 8 Prašno siva RAL 7037	115,00	143,75	165,00	206,25
	010193 *		009753 *	
MM 9 Metalik bakrena RAL extra	115,00	143,75	165,00	206,25
	009999 *		010001 *	
BHT – P.20 10 Tamno srebrna RAL 9007	115,00	143,75		
	096517 *			
MZ 11 Mahunasto zelena RAL 6005	115,00	143,75	165,00	206,25
	010094 *		010100 *	
MOT 12 Tamno plava RAL 5010	115,00	143,75	165,00	206,25
	010049 *		010056 *	
TZ 13 Travnato zelena RAL 6011	115,00	143,75	165,00	206,25
	010339 *		010346 *	
Pak. u kom 	1		1	
Pak. u kom 	40		40	

* Proizvodnja po narudžbi

OBUJMICA S GUMOM M10

P-POB-OZR

Nominalna veličina	EAN broj narudžbe	Pak. u kom		Cijena [€/kom]	
				Bez PDV	S PDV
80	002525	25	1 250	1,55	1,94
100	002532	25	1 250	2,00	2,50
120	002549	20	1 000	2,25	2,81



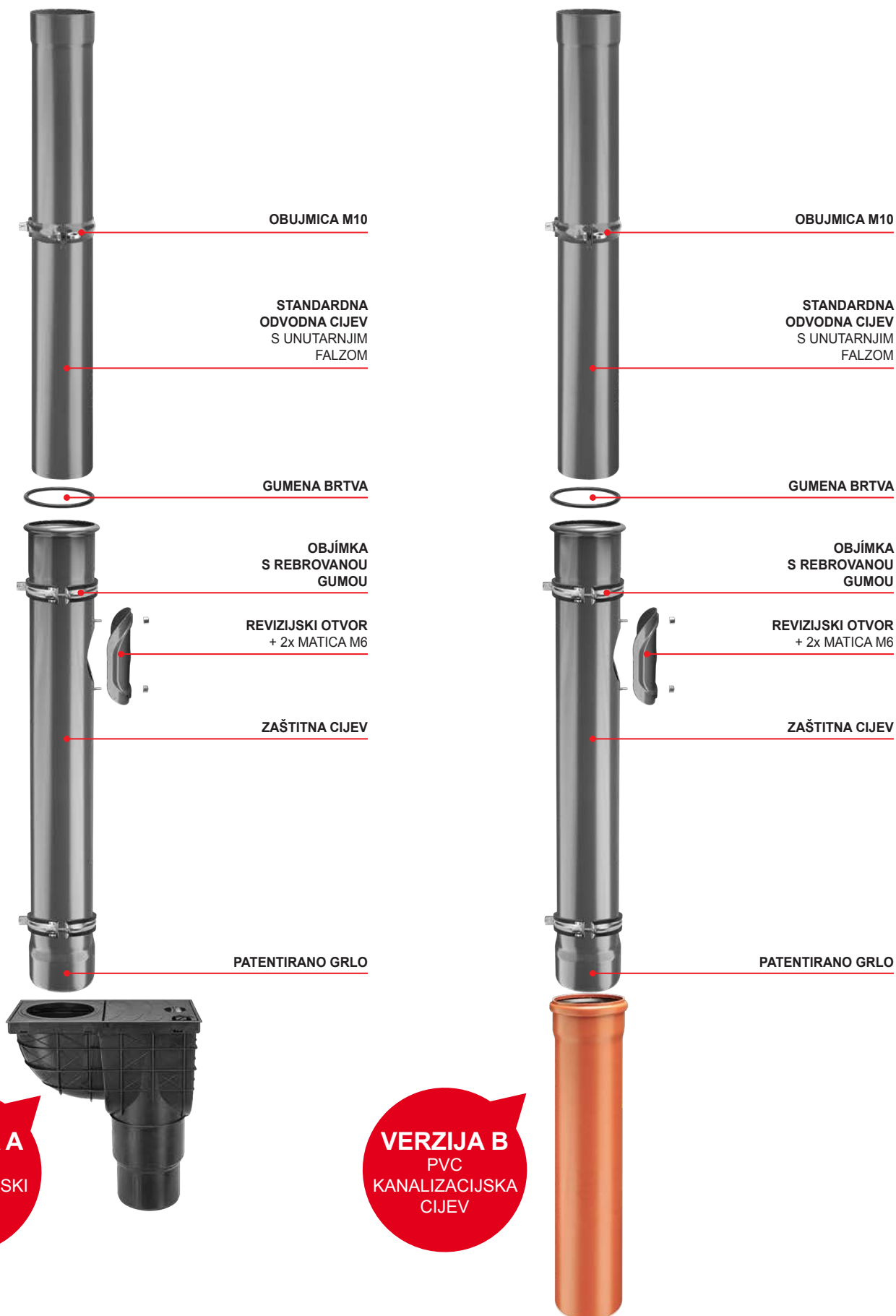

VERZIJA A
PVC
KANALIZACIJSKI
ISPUST

VERZIJA B
PVC
KANALIZACIJSKA
CIJEV

POCINK
POLYESTER

I. OPĆE ODREDBE

- 1.1. Trgovačko društvo sa sjedištem u Donjem Knežincu (Općina Gornji Knežinec), Ulica Kralja Andrije II 4, OIB: 73220465365, zastupano po direktoru Eduardu Kollaru ml. (dalje u tekstu: Prodavatelj) objavljuje ove Opće uvjete poslovanja koji se odnose na kupoprodaju odvodnih sistema kao i lakih krovnih pokriva, trapeza, limova krovne opreme, alata, strojeva i ostale robe vezane za krovne sisteme te drugu robu iz prodajno proizvodnog asortimana Prodavatelja (dalje u tekstu: Roba).
- 1.2. Opći uvjeti čine sastavni dio ugovora o kupoprodaji između pojedinog kupca i društva KJG d.o.o. sa sjedištem u Donjem Knežincu (Općina Gornji Knežinec), Ulica Kralja Andrije II 4, OIB: 73220465365, zastupano po direktoru Eduardu Kollaru ml. kao prodavatelja nastao ugovorenim kupnjom pojedinog proizvoda iz proizvodno-prodajnog asortimana Prodavatelja.
- 1.3. Ovim općim uvjetima reguliraju se međusobna prava i obveze u svrhu neometenog i brzog poslovanja između Kupca i Prodavatelja, a koje će nastati s osnovu kupoprodaje proizvoda iz asortimana Prodavatelja.
- 1.4. Prodavatelj prodaje i isporučuje robu samo u skladu s ovim Općim uvjetima.
- 1.5. U slučajevima naručivanja specifičnih, nestandardnih proizvoda s Kupcem se ugovaraju posebni uvjeti prodaje i plaćanja. Svaka izmjena mora biti sastavljena u pisanoj formi i potpisana od odgovornih osoba ugovornih strana.
- 1.6. Ovi opći uvjeti zajedno s pisanom prihvatom ponude Kupca čine ugovor.

II. PONUDE, NARUŽBA I CIJENE I SKLAPANJE UGOVORA

- 2.1. Ponuda Prodavatelja zasniva se na važećim cjenicima i katalogima proizvoda Prodavatelja. Kupac je isključivo odgovoran za ispravan odabir vrste proizvoda i njihove količine.
- 2.2. Ponuda Prodavatelja može biti prihvaćena samo pisanim putem.
- 2.3. Pisana i ovjerena narudžba Kupca smatra se temeljem za sklapanje ugovora o kupoprodaji.
- 2.4. Narudžba Kupca mora sadržavati:
 - * tvrtku, sjedište, OIB i odgovornu osobu Kupca
 - * specifikaciju naručene robe (tip, vrsta, količina i dimenzija), mjesto isporuke, težinu i način isporuke
 - * datum narudžbe,
 - * ime i prezime, funkciju osobe koja je ovlaštena preuzeti robu za Kupca
 - * u slučaju da se naručena roba, po nalogu Kupca, ima isporučiti trećoj osobi, takav nalog mora biti naznačen na narudžbi s točnom naznakom imena i adrese treće osobe, s time da se potpis i štambilj treće osobe na otpremnici Prodavatelja uzima kao potvrda da je roba isporučena Kupcu
- 2.5. Stranke će posebnim pogodbama ugovoriti rokove plaćanja, limite, vrijeme i način isporuke robe i druge međusobne obveze i prava pojedinog poslovnog odnosa.
- 2.6. Nakon što se stranke usuglase o posebnim pogodbama, ugovor o kupoprodaji se smatra sklopljenim u trenutku ovjere narudžbe od strane Prodavatelja

III. CIJENA I NAČIN PLAĆANJA

- 3.1. Kupac se obvezuje Prodavatelju naručenu robu platiti u ugovorenom roku i ugovorenoj prodajnoj cijeni. Prodajna cijena utvrđuje se prema cjeniku Prodavatelja (cijene su bez PDV-a) na dan narudžbe. Ukupna cijena narudžbe sa uključenim PDV-om biti će navedena prilikom ovjere narudžbe od strane Prodavatelja.
- 3.2. Na vrijednost robe koja se prodaje inozemnom kupcu (izvoz) ne obračunava se PDV.
- 3.3. **Limit dugovanja ugovorne strane ugovaraju posebnim pogodbama.**
- 3.4. U slučaju prekoračenja odobrenog limita ili prekoračenja ugovorenih rokova plaćanja Prodavatelj je ovlašten obavijestiti daljnju isporuku robe, sve dok dugovanje Kupca ne padne ispod dozvoljenog limita, odnosno, dok Kupac ne plati dospjele račune, ili dok Kupac ne preda Prodavatelju odgovarajuće jamstvo.
- 3.5. Plaćanjem na vrijeme se smatra isključivo kada je uplata vidljiva na računu Prodavatelja ili ako se uplata na dan dospjeća izvrši gotovinom na blagajni Prodavatelja
- 3.6. Ukoliko Kupac ne plati ispostavljeni račun u roku, Prodavatelj ima pravo obračunati zakonsku zateznu kamatu

IV. ISPORUKA ROBE I ZADRŽAVANJE PRAVA VLASNIŠTVA

- 4.1. Prodavatelj je dužan Kupcu isporučiti robu u ugovorenom roku.
- 4.2. Prodavatelj je dužan Kupcu isporučiti robu kvalitete izrade prikladne za svrhu u koju će se roba koristiti.
- 4.3. Kupac je dužan naručenu i isporučenu robu preuzeti.
- 4.4. Prodavatelj je dužan robu zapakirati i organizirati prijevoz na način na koji je to za naručenu robu uobičajeno i predviđeno – osim ukoliko se stranke drugačije ne dogovore.
- 4.5. Isporučka robe se obavlja u vrijeme i na način koji je definiran posebnim pogodbama.
- 4.6. Ukoliko se roba preuzima u sjedištu Prodavatelja, osoba koja preuzima robu u ime i za račun Kupca dužna je skladišnom radniku Prodavatelja dokazati pravo na preuzimanje robe
- 4.7. Prilikom dostave na adresu Kupca Kupac je dužan ovjeriti otpremnicu kao znak da je roba doista preuzeta
- 4.8. Kupac je dužan ovjeriti čitljivim potpisom osobe preuzimatelja robe i štambiljem Kupca svaku otpremnicu kao znak da je roba doista isporučena i preuzeta
- 4.9. U slučaju da roba mora biti dostavljena na adresu Kupca, Prodavatelj će naplatiti dostavu po važećem cjeniku na dan narudžbe. Također, Prodavatelj zadržava pravo isporučiti robu na pristupačnom terenu.
- 4.10. Za robu koja se šalje poštom, Prodavatelj će Kupcu naplatiti troškove poštarine, osim ako nije drugačije dogovoreno.
- 4.11. Kupac se obavezuje preuzeti robu u ugovorenom roku, u suprotnom ulazi u zakašnjenje. U slučaju da Kupac ne ispuni svoju obavezu, Prodavatelj ga može pozvati na ispunjenje svoje obaveze u dodatnom roku. Ako Kupac ne podigne robu niti u dodatnom roku Prodavatelj je ovlašten raskinuti ugovor.
- 4.12. Prodavatelj zadržava sva vlasnička prava na robu koju isporučuje, sve dok Kupac u potpunosti ne plati ugovorenu cijenu.

V. OBUSTAVA ISPORUKE

- 5.1. Ukoliko Kupac ne ispuni jednu ili više svojih obveza ili to ne obavi ispravno i u skladu sa ugovorom primjenjuje se slijedeće:
 - * Obveze Prodavatelja se automatizmom i bez odgode obustavljaju sve dok Kupac ne podmiri svoja dugovanja (uključivo plaćanje sudskih i van sudskih troškova)
 - * Prodavatelj može zahtijevati potpunu isplatu i/ili odgovarajuće jamstvo Kupca (npr. bankarska garancija)
- 5.2. Prodavatelj ima pravo zatražiti od Kupca isplatu i/ili odgovarajuće jamstvo plaćanja ukoliko postoji opravdana sumnja da Kupac neće ili ne može ispuniti svoje obveze u ugovorenom roku

VI. RIZIK

- 6.1. Do predaje robe Kupcu rizik slučajne propasti ili oštećenja stvari snosi Prodavatelj, a s predajom stvari rizik prelazi na Kupca.
- 6.2. Ako je prodavatelj dužan poslati robu Kupcu, mora sklopiti na uobičajeni način i pod uobičajenim uvjetima ugovore potrebne za izvršenje prijevoza do određenog mjesta, s time da rizik od slučajne propasti ili oštećenja prelazi na Kupca u trenutku predaje robe poštanskoj službi.
- 6.3. Ako robu Kupac preuzima na skladištu Prodavatelja (osobno ili putem prijevoznika) rizik od slučajne propasti ili oštećenja prelazi na Kupca u trenutku predaje robe bilo Kupcu bilo prijevozniku.
- 6.4. Kupac je dužan bez odgode primljenu robu na uobičajeni način pregledati ili je dati na pregled.

VII. ODGOVORNOST ZA NEDOSTATKE I JAMSTVO

- 7.1. Prodavatelj odgovara za materijalne nedostatke robe koje je ona imala u trenutku prijelaza rizika na kupca, bez obzira je li mu to bilo poznato.
- 7.2. Prodavatelj odgovara i za one materijalne nedostatke koji se pojave nakon prijelaza rizika na Kupca, ukoliko Kupac može dokazati da su nedostaci posljedica uzroka koji je postojao prije prijelaza rizika
- 7.3. Kupac je dužan obavijestiti Prodavatelja o vidljivim nedostacima na primljenoj robu bez odgađanja.
- 7.4. Kad se nakon primitka robe od strane Kupca pokaže da roba ima neki nedostatak koji se nije mogao otkriti uobičajenim pregledom prilikom preuzimanja stvari, Kupac je dužan, pod prijetnjom gubitka prava, o tom nedostaku obavijestiti Prodavatelja bez odgađanja
- 7.5. Nedostaci se moraju opisati na način da ih Prodavatelj može provjeriti. Zbog toga Kupac mora voditi evidenciju o korištenju robe, a u slučaju preprodaje robe, isto je dužan zatražiti od svojih kupaca.
- 7.6. Kupac je dužan ograničiti na najmanju moguću mjeru štete na isporučenoj robi, za koju podnosi reklamaciju Prodavatelju.
- 7.7. Prodavatelj ne odgovara za nedostatke koji se pokažu pošto protekne jedan mjesec od primitka robe
- 7.8. Ako Prodavatelj jamči za ispravnost stvari u tijeku određenog vremena (jamstvo), postupak reklamacije biti će definiran posebnim jamstvenim listom
- 7.9. Jamstveni rok teče do dana preuzimanja robe. Ako Prodavatelj dostavlja robu Kupcu, jamstveni rok počinje teći od datuma kada je roba dostavljena na odredište. Jamstveni rok se produljuje za razdoblje u kojem Kupac ne može koristiti robu zbog nedostataka za koje odgovara Prodavatelj.
- 7.10. Ako Prodavatelj jamči za ispravnost robe u tijeku određenog vremena, računajući od njezine predaje Kupcu, Kupac može, ako roba nije ispravna, zahtijevati od Prodavatelja da stvar popravi u razumnom roku ili, ako to ne učini, da mu umjesto nje preda ispravnu stvar.
- 7.11. Kupci koji su ostvarili određeni rabat na nabavnu cijenu robe, nemaju pravo na naknadu zbog izgubljene zarade uslijed nedostatka na primljenoj robi

VIII. VIŠA SILA

- 8.1. Viša sila podrazumijeva okolnosti u kojima je ispunjenje obveza nemoguće ili nerazmjerno otežano, a koje se ne mogu pripisati Prodavatelju. Takve okolnosti mogu uključivati štrajkove, požare, ekstremne klimatske uvjete, vladine mjere, kao i nedostatke u proizvodima isporučenicima Prodavatelju, te druge vanjske, izvanredne i nepredvidive okolnosti nastale poslije sklapanja ugovora.
- 8.2. Svaka ugovorna strana dužna je bez odgode obavijestiti drugu o nastupu okolnosti iz prethodnog članka.
- 8.3. Ukoliko okolnosti nastale djelovanjem više sile traju duže od 30 dana, obje strane imaju pravo raskinuti ugovor. U tom slučaju Prodavatelj ne odgovara za štetu Kupcu.

IX. ZAŠTITA OSOBNIH PODATAKA

- 9.1. Prodavatelj radi brže poslovne komunikacije s Kupcem može za obradu poslovne dokumentacije i poslovnih događanja koristiti računalnu obradu podataka. S tim u vezi Prodavatelj jamči Kupcu da će sve podatke koji su mu posljedjeni u svrhu poslovanja koristiti isključivo u opsegu potrebnom za obradu podataka.
- 9.2. Kupac daje Prodavatelju suglasnost za upotrebu podataka Kupca u svrhu:
 - a/ ostvarivanja prava i obveza koja proizlaze i kupoprodajnog odnosa
 - b/ vođenja evidencije obveza Kupca prema Prodavatelju
 - c/ provođenja marketinških aktivnosti

X. RJEŠAVANJE SPOROVA

- 10.1. Sve sporove koji bi proizašli iz ovih Uvjeta ili u vezi s njima, odnosno iz ugovora između Prodavatelja i Kupca ili u vezi s njima, uključujući i sporove koji se odnose na pitanja njihova valjana nastanka, povrede ili prestanka, kao i na pravne učinke koji iz toga proistječu, stranke će pokušati riješiti mirnim putem, no, ukoliko to ne bude moguće za rješavanje nastalih sporova biti će nadležan stvarno nadležni sud u Varaždinu.

XI. SALVATORSTA KLAUZULA

- 11.1. Ako bilo koja od odredbi ovih Općih uvjeta postane ništeta, ta će se odredba zamijeniti valjanom odredbom, koja u što većoj mjeri odgovara sadržaju i trgovačkom cilju koji su ugovorne strane htjele postići ranijom odredbom koja je proglašena ništetnom. Ukoliko ima više ništetnih odredbi, ova klauzula se primjenjuje na svaku ništetnu odredbu.
- 11.2. U tom slučaju ostale odredbe Općih uvjeta ostaju na snazi.

XII. ZAVRŠNE ODREDBE

- 12.1. Kupac nema pravo prenijeti svoja prava definirana ugovorom o kupoprodaji trećoj strani bez pismenog pristanka Prodavatelja
- 12.2. Uvjeti kupoprodaje koji se utvrđuju posebnim pogodbama moguće je mijenjati isključivo pismenim pute, zaključenjem Anexa ugovoru, koji je potpisani ovjeren od obje ugovornih strana
- 12.3. Kupac potvrđuje da je upoznat s ovim Općim uvjetima, da je pročitao Opće uvjete, da pristaje na njihovu primjenu, te da prihvaća sva prava i obveze koje proistječu iz ovih uvjeta