



GALVANIZED
STEEL

PREPA
INTED

GUTTER SYSTEM SEMI CIRCULAR – CIRCULAR



PRICE LIST

2024

RECOMMENDED CONSUMER PRICES



POWERFUL PARTNER FOR YOUR ROOF



Prepainted galvanized steel | 3



Gutter | 6

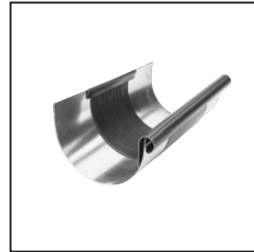

Gutter expanders | 12



Gutter accessories | 15



Gutter hook | 19



Corner | 24



End Cap | 26



Outlet | 28



Elbow | 40



Downpipe | 45



Downpipe accessories | 52



Pipe bracket | 55



Pipe bracket accessories | 59



Downpipe flap | 62



Protective gutter pipe | 65



**GALVA
NIZED
STEEL**

**PREPA
INTED**

GUTTER SYSTEM SEMI CIRCULAR – CIRCULAR

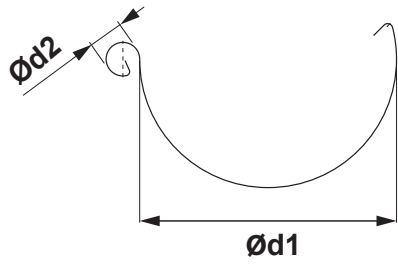

ROOF GUTTER DIMENSIONS

(dimensions and dimensional tolerances according to EN 612)

Developed width (mm)	200	250	280	333	400	500
Ød1	80	105	127	153	192	250
Ød2	16	18	18	20	22	22

INNER FOLD

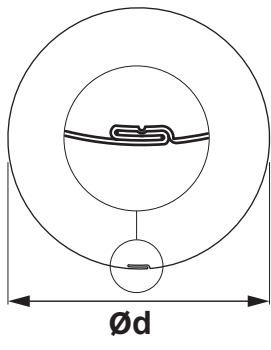

SPOUT PIPE DIMENSIONS

(dimensions and dimensional tolerances according to EN 612)

Dimensions	60	80	100	120	150
Nominal size Ød (mm)	60	80	100	120	150

GUTTER BRACKET DIMENSIONS

(dimensions and dimensional tolerances according to EN 612)

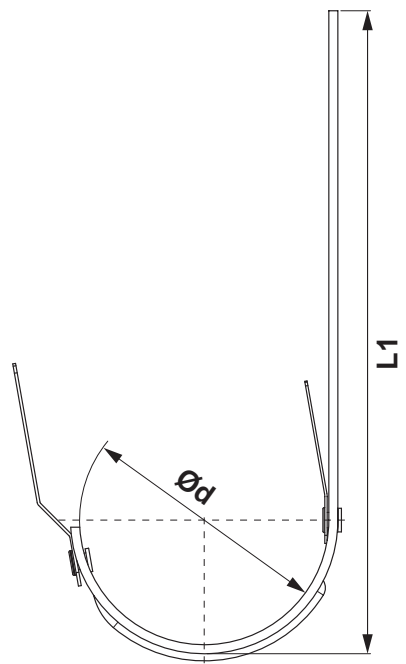

Dimensions (mm)	L1	Ød
200	290	80
250	310	105
280	345	127
333 – 550	385	153
333 – 610	445	153
400	400	192



GALVANIZED STEEL

PREPAINTED

GALVANIZED STEEL POLYESTER

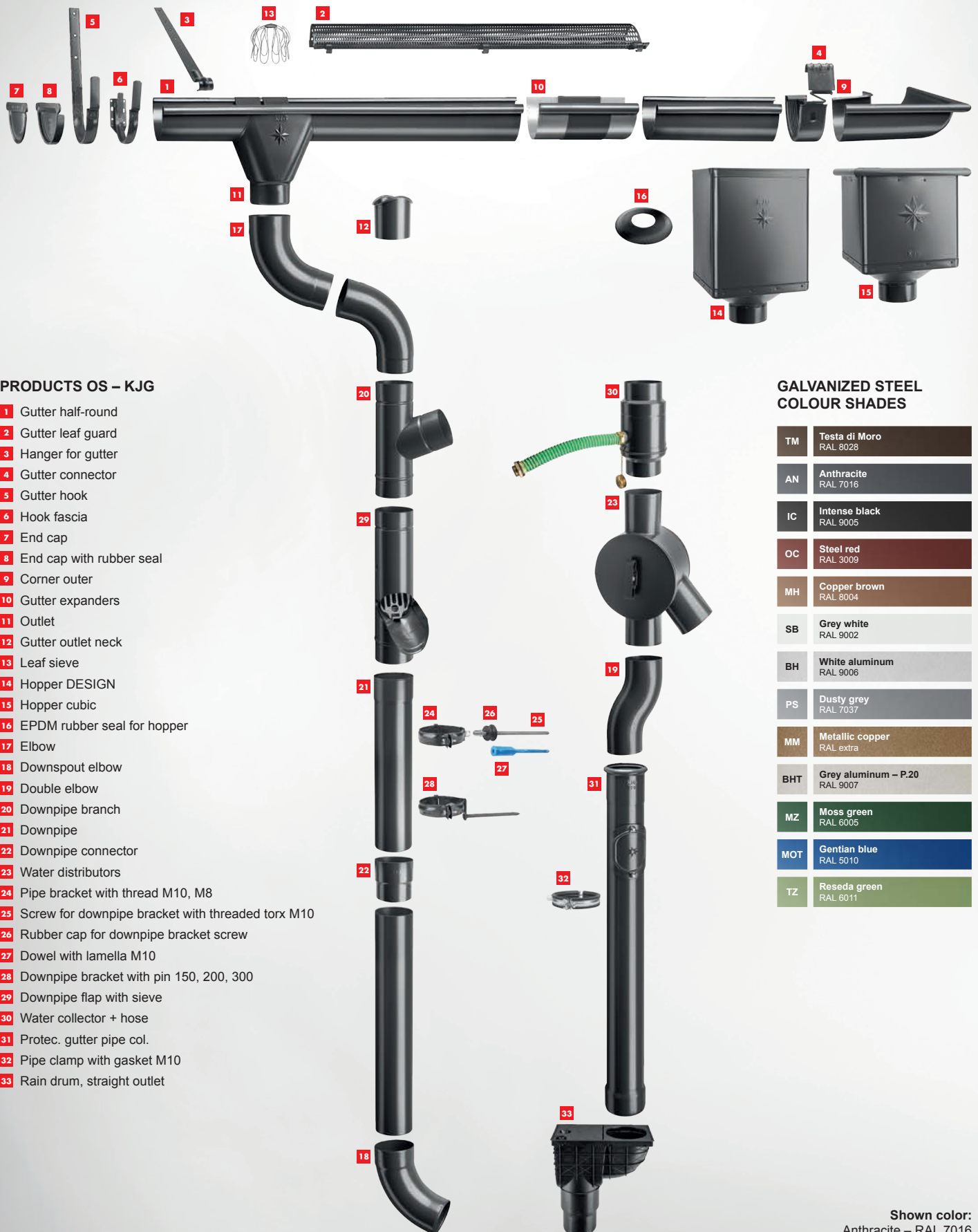

PRODUCTS OS – KJG

- 1** Gutter half-round
- 2** Gutter leaf guard
- 3** Hanger for gutter
- 4** Gutter connector
- 5** Gutter hook
- 6** Hook fascia
- 7** End cap
- 8** End cap with rubber seal
- 9** Corner outer
- 10** Gutter expanders
- 11** Outlet
- 12** Gutter outlet neck
- 13** Leaf sieve
- 14** Hopper DESIGN
- 15** Hopper cubic
- 16** EPDM rubber seal for hopper
- 17** Elbow
- 18** Downspout elbow
- 19** Double elbow
- 20** Downpipe branch
- 21** Downpipe
- 22** Downpipe connector
- 23** Water distributors
- 24** Pipe bracket with thread M10, M8
- 25** Screw for downpipe bracket with threaded torx M10
- 26** Rubber cap for downpipe bracket screw
- 27** Dowel with lamella M10
- 28** Downpipe bracket with pin 150, 200, 300
- 29** Downpipe flap with sieve
- 30** Water collector + hose
- 31** Protec. gutter pipe col.
- 32** Pipe clamp with gasket M10
- 33** Rain drum, straight outlet

GALVANIZED STEEL COLOUR SHADES

TM	Testa di Moro RAL 8028
AN	Anthracite RAL 7016
IC	Intense black RAL 9005
OC	Steel red RAL 3009
MH	Copper brown RAL 8004
SB	Grey white RAL 9002
BH	White aluminum RAL 9006
PS	Dusty grey RAL 7037
MM	Metallic copper RAL extra
BHT	Grey aluminum – P.20 RAL 9007
MZ	Moss green RAL 6005
MOT	Gentian blue RAL 5010
TZ	Reseda green RAL 6011

Shown color:
Anthracite – RAL 7016



GALVANIZED STEEL POLYESTER

TATA STEEL





The company Tata was founded in 1868 by Jamsetji Nusserwanji Tata and headquartered in India. It is a global business conglomerate operating in over 100 countries across 5 continents. From an early foray into steel and automobiles, to staying abreast of the latest technologies, the Tata Group today has a strong position across diverse industries such as agrochemicals, automotive, chemicals, construction, finance, consumer products and hospitality.

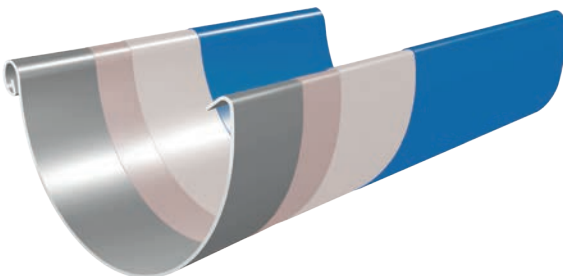

MARCEGAGLIA

Marcegaglia is the Italian leading player and the largest independent global operator in the steel processing industry. With 5.6 million tons processed each year and turnover more than 5 billion euros (2017), Marcegaglia is an Italian industrial group, which is a leading player in Europe and worldwide in the transformation of steel. The acquired leadership is the result of a long, solid and steady growth path, which makes Marcegaglia the largest independent global player in steel transformation.



-  Top coating layer (approx. 20 μm) on a polyester base for excellent aesthetics and the highest resistance to damage
-  Primer (approx. 5 μm) for perfect adhesion and strong anti-corrosion protection
-  Zinc layer (225 g/m^2) for permanent anti-corrosion protection
-  Optimized steel coil for OS – KJG gutter system

GALVANIZED STEEL POLYESTER

GUTTER HALF-ROUND [s=0,55]

P-PZ

Nominal dimension	200	200	200
Length in m	2,0	3,0	4,0
Price in €/m	With VAT	With VAT	With VAT
TM 1 Testa di Moro RAL 8028	8,34 043610	8,34 043627	8,34 043634
AN 2 Anthracite RAL 7016	8,34 042187	8,34 042194	8,34 042200
IC 3 Intense black RAL 9005	8,34 042545	8,34 042552	8,34 042569
OC 4 Steel red RAL 3009		8,34 043191	8,34 043207
MH 5 Copper brown RAL 8004		8,46 042750	
SB 6 Grey white RAL 9002		8,46 043498	
BH 7 White aluminum RAL 9006		8,46 042392	8,46 042408
PS 8 Dusty grey RAL 7037		8,46 043375	8,46 043382
MM 9 Metallic copper RAL extra		9,00 042927	
BHT – P.20 10 Grey aluminum RAL 9007			
MZ 11 Moss green RAL 6005		9,00 043085	
MOT 12 Gentian blue RAL 5010		9,00 043016 *	
TZ 13 Reseda green RAL 6011		9,00 043825 *	
Package in m 	10	15	20
Package in m 	800	1 200	1 600

* Custom production

GALV. STEEL
POLYESTER



GALVANIZED STEEL POLYESTER

GUTTER HALF-ROUND [s=0,55]

P-PZ

Nominal dimension	250	250	250	250	250
Length in m	2,0	3,0	4,0	5,0	6,0
Price in €/m	With VAT	With VAT	With VAT	With VAT	With VAT
TM 1 Testa di Moro RAL 8028	7,44	7,26	7,26	7,26	7,26
	043641	043658	043665	043672	043689
AN 2 Anthracite RAL 7016	7,44	7,26	7,26	7,26	7,26
	042217	042224	042231	042248	042255
IC 3 Intense black RAL 9005	7,44	7,26	7,26	7,26	7,26
	042576	042583	042590	042606	042613
OC 4 Steel red RAL 3009	7,44	7,26	7,26	7,26	7,26
	043214	043221	043238	043245	043252
MH 5 Copper brown RAL 8004	7,56	7,38	7,38	7,38	7,38
	042774	042781	042798	042804	042811
SB 6 Grey white RAL 9002		7,38	7,38		7,38
		043504	043511		043528
BH 7 White aluminum RAL 9006		7,38	7,38	7,38	7,38
		042415	042422	042439	042446
PS 8 Dusty grey RAL 7037			7,38		7,38
			043399		043405
MM 9 Metallic copper RAL extra			7,80		7,80
			042934		042941
BHT – P.20 10 Grey aluminum RAL 9007			9,00		
			095466		
MZ 11 Moss green RAL 6005			7,80		7,80
			043092		043108
MOT 12 Gentian blue RAL 5010			7,80		
			043023		
TZ 13 Reseda green RAL 6011			7,80		
			043832		
Package in m 	10	15	20	25	30
Package in m 	480	720	960	1 200	1 440



GALVANIZED STEEL POLYESTER

GUTTER HALF-ROUND [s=0,55]

P-PZ

Nominal dimension	280	280	280	280	280
Length in m	2,0	3,0	4,0	5,0	6,0
Price in €/m	With VAT	With VAT	With VAT	With VAT	With VAT
TM 1 Testa di Moro RAL 8028	8,40	8,22	8,22	8,22	8,22
	043696	043702	043719	043726	043733
AN 2 Anthracite RAL 7016	8,40	8,22	8,22	8,22	8,22
	042262	042279	042286	042293	042309
IC 3 Intense black RAL 9005	8,40	8,22	8,22	8,22	8,22
	042620	042637	042644	042651	042668
OC 4 Steel red RAL 3009		8,22	8,22	8,22	8,22
		043269	043276	043283	043290
MH 5 Copper brown RAL 8004		8,34	8,34		8,34
		042828	042835		042842
SB 6 Grey white RAL 9002			8,34		8,34
			043535		043542
BH 7 White aluminum RAL 9006		8,34	8,34		8,34
		042453	042460		042477
PS 8 Dusty grey RAL 7037			8,34		8,34
			043412		043429
MM 9 Metallic copper RAL extra			8,94		8,94
			042958		042965
BHT – P.20 10 Grey aluminum RAL 9007			10,08		
			095473		
MZ 11 Moss green RAL 6005			8,94		8,94
			043115		043122
MOT 12 Gentian blue RAL 5010			8,94		
			043030		
TZ 13 Reseda green RAL 6011			8,94		
			043849		
Package in m 	10	15	20	25	30
Package in m 	420	630	840	1 050	1 260

GALV. STEEL
POLYESTER



GALVANIZED STEEL POLYESTER

GUTTER HALF-ROUND [s=0,55]

P-PZ



Nominal dimension	333	333	333	333	333
Length in m	2,0	3,0	4,0	5,0	6,0
Price in €/m	With VAT	With VAT	With VAT	With VAT	With VAT
TM 1 Testa di Moro RAL 8028	8,76	8,52	8,52	8,52	8,52
	043740	043757	043764	043771	043788
AN 2 Anthracite RAL 7016	8,76	8,52	8,52	8,52	8,52
	042316	042323	042330	042347	042354
IC 3 Intense black RAL 9005	8,76	8,52	8,52	8,52	8,52
	042675	042682	042699	042705	042712
OC 4 Steel red RAL 3009	8,76	8,52	8,52	8,52	8,52
	043306	043313	043320	043337	043344
MH 5 Copper brown RAL 8004	8,88	8,64	8,64	8,64	8,64
	042859	042866	042873	042880	042897
SB 6 Grey white RAL 9002		8,64	8,64	8,64	8,64
		043559	043566	043573	043580
BH 7 White aluminum RAL 9006		8,64	8,64	8,64	8,64
		042484	042491	042507	042514
PS 8 Dusty grey RAL 7037		8,64	8,64	8,64	8,64
		043436	043443	043450	043467
MM 9 Metallic copper RAL extra			9,96	9,96	9,96
			042972	042989	042996
BHT – P.20 10 Grey aluminum RAL 9007			10,20		10,20
			095480		095497
MZ 11 Moss green RAL 6005			9,96	9,96	9,96
			043139	043146	043153
MOT 12 Gentian blue RAL 5010			9,96		9,96
			043047		043054
TZ 13 Reseda green RAL 6011			9,96		
			043856		
Package in m 	10	15	20	25	30
Package in m 	330	495	660	825	990



GALVANIZED STEEL POLYESTER

GUTTER HALF-ROUND [s=0,55]

P-PZ

Nominal dimension	400	400	500	500	333
Length in m	4,0	6,0	4,0	6,0	7,0
Price in €/m	With VAT	With VAT	With VAT	With VAT	With VAT
TM 1 Testa di Moro RAL 8028	13,74	13,74			8,52
	043801	043818			043795 *
AN 2 Anthracite RAL 7016	13,74	13,74	18,60	18,60	
	042361	042378	086730 *	086747 *	
IC 3 Intense black RAL 9005	13,74	13,74			
	042729	042736			
OC 4 Steel red RAL 3009	13,74	13,74			
	043351	043368			
MH 5 Copper brown RAL 8004	13,86	13,86			
	042903	042910			
SB 6 Grey white RAL 9002	13,86	13,86	18,72	18,72	
	043597	043603	086778 *	086785 *	
BH 7 White aluminum RAL 9006	13,86	13,86	18,72	18,72	
	042521	042538	086754 *	086761 *	
PS 8 Dusty grey RAL 7037	13,86	13,86			
	043474	043481			
MM 9 Metallic copper RAL extra	14,58				
	043009				
BHT – P.20 10 Grey aluminum RAL 9007		15,36			
		095503			
MZ 11 Moss green RAL 6005	14,58	14,58			
	043160	043177 *			
MOT 12 Gentian blue RAL 5010	14,58	14,58			
	043061	043078			
TZ 13 Reseda green RAL 6011	14,58				
	043863 *				
Package in m 	20	30	20	30	35
Package in m 	540	810	–	–	1 155

* Custom production

GALV. STEEL
POLYESTER



GALVANIZED STEEL POLYESTER

GUTTER ON-ROOF [s=0,55]

P-PZS

Nominal dimension	650	650
Length in m	4,0	6,0
Price in €/m	With VAT	With VAT
TM 1 Testa di Moro RAL 8028	26,40 049926	26,40 049933
AN 2 Anthracite RAL 7016	26,40 049759	26,40 049766
IC 3 Intense black RAL 9005	26,40 049797	26,40 049803
OC 4 Steel red RAL 3009	26,40 049865	26,40 049872
MH 5 Copper brown RAL 8004	27,36 049810	27,36 049827
SB 6 Grey white RAL 9002	27,36 049902	
BH 7 White aluminum RAL 9006	27,36 049773	27,36 049780
PS 8 Dusty grey RAL 7037	27,36 049889	
MM 9 Metallic copper RAL extra	30,24 049834	
BHT – P.20 10 Grey aluminum RAL 9007	35,10 095749 *	
MZ 11 Moss green RAL 6005	30,24 049858	
MOT 12 Gentian blue RAL 5010	30,24 049841 *	
TZ 13 Reseda green RAL 6011	30,24 049940 *	
Package in m 	4	6
Package in m 	200	300

* Custom production



GUTTER EXPANDERS

P-PZDI

Nominal dimension	250/260	280/260	333/260	400/260
Price in €/pcs	With VAT	With VAT	With VAT	With VAT
TM 1 Testa di Moro RAL 8028	17,52	18,60	20,28	23,88
	013064	013071	013088	013095
AN 2 Anthracite RAL 7016	17,52	18,60	20,28	23,88
	012661	012678	012685	012692
IC 3 Intense black RAL 9005	17,52	18,60	20,28	23,88
	012746 *	012753 *	012760	012777 *
OC 4 Steel red RAL 3009	17,52	18,60	20,28	23,88
	012944 *	012951 *	012968 *	012975 *
MH 5 Copper brown RAL 8004	17,52	18,60	20,28	23,88
	012784 *	012791 *	012807 *	012814 *
SB 6 Grey white RAL 9002	17,52	18,60	20,28	23,88
	013026 *	013033 *	013040 *	013057 *
BH 7 White aluminum RAL 9006	17,52	18,60	20,28	23,88
	012708 *	012715 *	012722 *	012739 *
PS 8 Dusty grey RAL 7037	17,52	18,60	20,28	23,88
	012982 *	012999 *	013002 *	013019 *
MM 9 Metallic copper RAL extra	17,52	18,60	20,28	23,88
	012821 *	012838 *	012845 *	012852 *
BHT – P.20 10 Grey aluminum RAL 9007	17,52	18,60	20,28	23,88
	096098 *	096104 *	096111 *	114044 *
MZ 11 Moss green RAL 6005	17,52	18,60	20,28	23,88
	012906 *	012913 *	012920 *	012937 *
MOT 12 Gentian blue RAL 5010	17,52	18,60	20,28	23,88
	012869 *	012876 *	012883 *	012890 *
TZ 13 Reseda green RAL 6011	17,52	18,60	20,28	23,88
	013101 *	013118 *	013125 *	013132 *
Package in pcs	3	3	5	5
Package in pcs	360	360	200	200

* Custom production

GALV. STEEL
POLYESTER

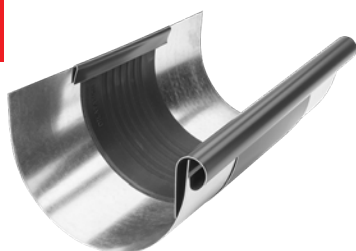

GALVANIZED STEEL POLYESTER

ON-ROOF GUTTER EXPANSION COMPONENT

P-PZSDI



Nominal dimension	670/260	
Price in €/pcs	With VAT	
TM 1 Testa di Moro RAL 8028	37,80	013637 *
AN 2 Anthracite RAL 7016	37,80	013545 *
IC 3 Intense black RAL 9005	37,80	013569 *
OC 4 Steel red RAL 3009	37,80	013606 *
MH 5 Copper brown RAL 8004	37,80	013576 *
SB 6 Grey white RAL 9002	37,80	013620 *
BH 7 White aluminum RAL 9006	37,80	013552 *
PS 8 Dusty grey RAL 7037	37,80	013613 *
MM 9 Metallic copper RAL extra	37,80	013583 *
BHT – P.20 10 Grey aluminum RAL 9007	37,80	096067 *
MZ 11 Moss green RAL 6005	37,80	013651 *
MOT 12 Gentian blue RAL 5010	37,80	013590 *
TZ 13 Reseda green RAL 6011	37,80	013644 *
Package in pcs	1	
Package in pcs	40	

* Custom production

ENDLESS TAPES

P-PZDIP



Nominal dimension	Length in m	EAN product number	Packaging in m		Cena with VAT [€/m]
260	3,0	012470	3	120	33,60
260	6,0	012487	6	240	33,60

USE OF DILATATION GUTTER AND DILATATION STRIP

DILATATION GUTTER

Installation example: hanging gutter with a developed width of up to 500 mm. The dilatation gutter shall be installed at spacing of 15 m. For outer corner and beginning of the gutter, a half of the standard value is applied: maximum 7,5 m. For inner corner, a quarter of the standard value is applied: maximum 3,75 m. For other materials and dimensions: see the table below. Corners are always taken into account as fixed points.

ROOF SEMICIRCULAR DILATATION GUTTERS

Developed gutter width	Aluminium	Steel, Titanium-zinc, Copper, Stainless steel
< 500	12	15
> 500	8	10

DILATATION STRIP

Indoor installation: on gutters attached without gluing to a substrate, roofs with non-standard profile and roof cladding

ROOF DILATATION STRIP

Developed gutter width	Aluminium	Steel, Titanium-zinc, Copper, Stainless steel
< 500	8	10
> 500	6	8

For outer corner or the beginning of the gutter, a half of the standard value shall be applied.

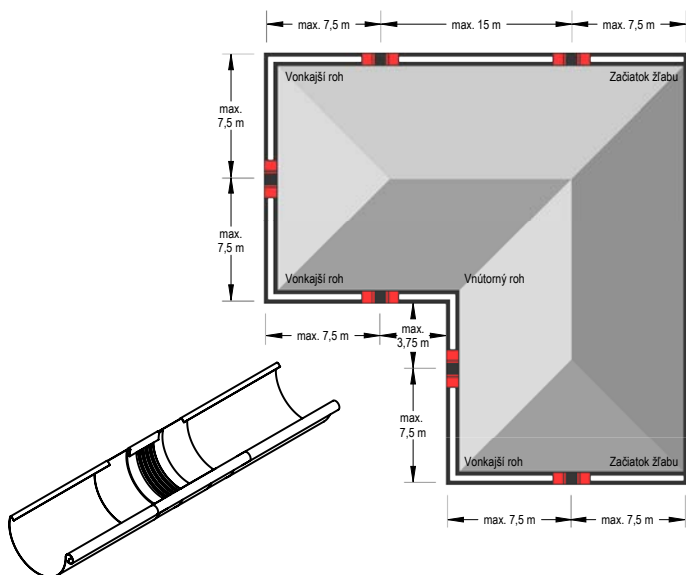

Note to the dilatation gutter mounting.

When mounting by soldering, first cover the middle rubber part with a wet cloth (to prevent heat transfer to the middle rubber part). A minimum distance of 6 cm from the middle rubber part must be kept. In any case avoid contact of rubber with open flame.

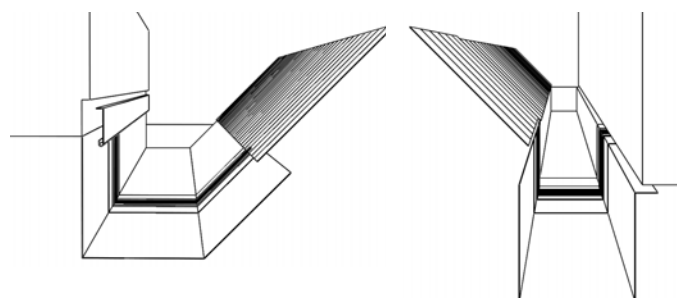

Note to the dilatation strip mounting.

When bending and mounting dilatation elements, make sure that:

- Bending jaws have a radius of at least 2 mm.
- For sheet metal thicknesses over 1 mm, it must be observed bending radius at least 5 mm.
- When bending, the bending jaws should be set to a thickness of the middle rubber part of 3 to 4 mm to prevent the cutting effect - damage to the rubber.
- The rubber middle part must not be compressed or damaged during bending. Therefore, an aluminium sheet strip 2 to 5 mm (thick) should be used, bent so that it can be attached as a protection to the bending jaws. This achieves a larger bending radius and prevents the rubber middle part from breaking.

ALUMINIUM GUTTER LEAF GUARD

P-PZNLNLM

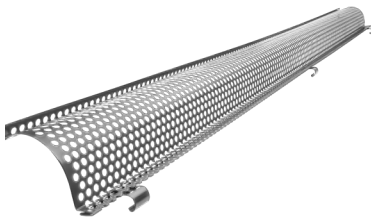





Nominal dimension		333
Length in m		2,0
Price in €/pcs		With VAT
TM 1 Testa di Moro RAL 8028		31,80 064943
AN 2 Anthracite RAL 7016		31,80 064912
IC 3 Intense black RAL 9005		31,80 064929 *
OC 4 Steel red RAL 3009		31,80 064936 *
MH 5 Copper brown RAL 8004		31,80 119766 *
SB 6 Grey white RAL 9002		31,80 117762 *
BH 7 White aluminum RAL 9006		31,80 117717 *
PS 8 Dusty grey RAL 7037		31,80 117755 *
MM 9 Metallic copper RAL extra		31,80 117724 *
BHT – P.20 10 Grey aluminum RAL 9007		31,80 097156 *
MZ 11 Moss green RAL 6005		31,80 117748 *
MOT 12 Gentian blue RAL 5010		31,80 117731 *
TZ 13 Reseda green RAL 6011		31,80 117779 *
Package in pcs		15
Package in pcs		120

* Custom production

GALVANIZED STEEL POLYESTER



PVC GUTTER GUARD

SD-ZNL MRIEZKA

Nominal dimension	Lenght in m	EAN product number	Packaging in pcs		Price with VAT [€/pcs]
					
 171	1,0	008473	30	450	5,40
 171	1,0	008466	30	450	5,40

PVC GUTTER GUARD

SD-ZNL N

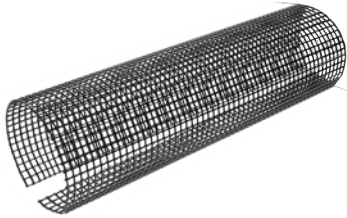
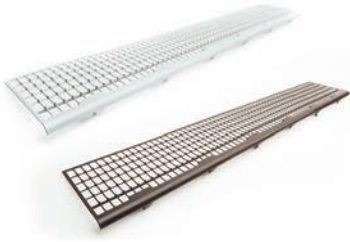

Nominal dimension	Lenght in m	EAN product number	Packaging in pcs		Price with VAT [€/pcs]
					
250	3,0	008480	10	400	28,68
280-333	3,0	008497	10	400	28,80



GALVANIZED STEEL POLYESTER

HANGER FOR GUTTER

P-PDZNV

Nominal dimension	250-280	333	400
Dimension in mm	18	20	22
Price in €/pcs	With VAT	With VAT	With VAT
TM 1 Testa di Moro RAL 8028	1,92 085665	1,92 085672	1,92 085689 *
AN 2 Anthracite RAL 7016	1,92 085290	1,92 085306	1,92 085313
IC 3 Intense black RAL 9005	1,92 085351	1,92 085368	1,92 085375 *
OC 4 Steel red RAL 3009	1,92 085504	1,92 085573	1,92 085597 *
MH 5 Copper brown RAL 8004	1,92 085382	1,92 085399	1,92 085405 *
SB 6 Grey white RAL 9002	1,92 085634 *	1,92 085641	1,92 085658 *
BH 7 White aluminum RAL 9006	1,92 085320	1,92 085337	1,92 085344 *
PS 8 Dusty grey RAL 7037	1,92 085603	1,92 085610	1,92 085627 *
MM 9 Metallic copper RAL extra	1,92 085412 *	1,92 085429	1,92 085436 *
BHT – P.20 10 Grey aluminum RAL 9007	1,92 094636 *	1,92 094643 *	1,92 094650 *
MZ 11 Moss green RAL 6005	1,92 085474 *	1,92 085481 *	1,92 085498 *
MOT 12 Gentian blue RAL 5010	1,92 085443 *	1,92 085450 *	1,92 085467 *
TZ 13 Reseda green RAL 6011	1,92 085696 *	1,92 085702 *	1,92 085719 *
Package in pcs 	25	25	25
Package in pcs 	3 000	3 000	3 000

* Custom production



GALVANIZED STEEL POLYESTER

GUTTER CONNECTOR

P-PSPZ

Nominal dimension	250	280	333
Price in €/pcs	With VAT	With VAT	With VAT
TM 1 Testa di Moro RAL 8028	4,56 083852	4,56 083869	4,80 083876
AN 2 Anthracite RAL 7016	4,56 083456	4,56 083463	4,80 083470
IC 3 Intense black RAL 9005	4,56 083531	4,56 083548	4,80 083555
OC 4 Steel red RAL 3009	4,56 083739	4,56 083746	4,80 083753
MH 5 Copper brown RAL 8004	4,56 083579	4,56 083586	4,80 083593
SB 6 Grey white RAL 9002	4,56 083814	4,56 083821	4,80 083838
BH 7 White aluminum RAL 9006	4,56 083494	4,56 083500	4,80 083517
PS 8 Dusty grey RAL 7037	4,56 083777	4,56 083784	4,80 083791
MM 9 Metallic copper RAL extra	4,56 083616	4,56 083623	4,80 083630
BHT – P.20 10 Grey aluminum RAL 9007	4,56 094681	4,56 094698 *	4,80 094704
MZ 11 Moss green RAL 6005	4,56 083692	4,56 083708	4,80 083715
MOT 12 Gentian blue RAL 5010	4,56 083654	4,56 083661	4,80 083678
TZ 13 Reseda green RAL 6011	4,56 083890 *	4,56 083906 *	4,80 083913
Package in pcs	5	5	5
Package in pcs	600	600	600



* Custom production

GALV. STEEL
POLYESTER



GUTTER HOOK

P-PHP

Nominal dimension	200/380	250/430	280/480	280/480
Material	25/4	25/5	25/5	30/5
Price in €/pcs	With VAT	With VAT	With VAT	With VAT
TM 1 Testa di Moro RAL 8028	3,96 045362	3,54 045379	3,78 045386	4,14 045393
AN 2 Anthracite RAL 7016	3,96 044648	3,54 044655	3,78 044662	4,14 044679
IC 3 Intense black RAL 9005	3,96 044808	3,54 044815	3,78 044822	4,14 044839
OC 4 Steel red RAL 3009	3,96 045140	3,54 045157	3,78 045164	4,14 045171
MH 5 Copper brown RAL 8004	3,96 044884	3,54 044891	3,78 044907	4,14 044914
SB 6 Grey white RAL 9002	3,96 045287	3,54 045294	3,78 045300	4,14 045317
BH 7 White aluminum RAL 9006	3,96 044723	3,54 044730	3,78 044747	4,14 044754
PS 8 Dusty grey RAL 7037	3,96 045225	3,54 045232		4,14 045249
MM 9 Metallic copper RAL extra	3,96 044969	3,54 044976		4,14 044983
BHT – P.20 10 Grey aluminum RAL 9007		3,54 095961		4,14 095978
MZ 11 Moss green RAL 6005	3,96 045089	3,54 045096		4,14 045102
MOT 12 Gentian blue RAL 5010	3,96 045027	3,54 045034		4,14 045041
TZ 13 Reseda green RAL 6011	3,96 045454 *	3,54 045461		4,14 045478
Package in pcs 	25	25	25	25
Package in pcs 	1 000	1 000	1 000	1 000

* Custom production



GALVANIZED STEEL POLYESTER

GUTTER HOOK

P-PHP

Nominal dimension	333/550	333/550	333/550	333/610	400/610
Material	25/5	30/4	30/5	30/5	25/5
Price in €/pcs	With VAT	With VAT	With VAT	With VAT	With VAT
TM 1 Testa di Moro RAL 8028	3,78	3,96	4,20	4,92	7,08
	045409	045416 *	045423	045430	045447
AN 2 Anthracite RAL 7016	3,78	3,96	4,20	4,92	7,08
	044686	080127 *	044693	044709	044716
IC 3 Intense black RAL 9005	3,78		4,20	4,92	7,08
	044846		044853	044860	044877
OC 4 Steel red RAL 3009	3,78		4,20	4,92	7,08
	045188		045195	045201	045218
MH 5 Copper brown RAL 8004	3,78		4,20	4,92	7,08
	044921		044938	044945	044952
SB 6 Grey white RAL 9002	3,78		4,20	4,92	7,08
	045324		045331	045348	045355
BH 7 White aluminum RAL 9006	3,78		4,20	4,92	7,08
	044761		044778	044785	044792
PS 8 Dusty grey RAL 7037			4,20	4,92	7,08
			045256	045263	045270
MM 9 Metallic copper RAL extra			4,20	4,92	7,08
			044990	045003	045010
BHT – P.20 10 Grey aluminum RAL 9007			4,20		7,08
			095985		095992
MZ 11 Moss green RAL 6005			4,20	4,92	7,08
			045119	045126	045133
MOT 12 Gentian blue RAL 5010			4,20	4,92	7,08
			045058	045065	045072
TZ 13 Reseda green RAL 6011			4,20	4,92	7,08
			045485	045492	045508 *
Package in pcs	25	25	25	25	25
Package in pcs	1 000	1 000	1 000	1 000	500

* Custom production



GALV. STEEL
POLYESTER



GALVANIZED STEEL POLYESTER

GUTTER HOOK WITH A NOSE



P-PHPN

Nominal dimension	250/430	280/480	333/550
Material	25/5	25/5	30/5
Price in €/pcs	With VAT	With VAT	With VAT
TM 1 Testa di Moro RAL 8028	3,48 095930	3,48 095947	3,84 095954
AN 2 Anthracite RAL 7016	3,48 095824	3,48 095831	3,84 095848
IC 3 Intense black RAL 9005		3,48 095879	3,84 095886 *
MH 5 Copper brown RAL 8004		3,48 095893	3,84 095909
SB 6 Grey white RAL 9002		3,48 095916	3,84 095923 *
BH 7 White aluminum RAL 9006		3,48 095855	3,84 095862
PS 8 Dusty grey RAL 7037			3,84 117496 *
Package in pcs 	25	25	25
Package in pcs 	1 000	1 000	1 000

* Custom production

GUTTER HOOK FASCIA WITH A NOSE

P-PHPNK

Nominal dimension	250	280	333
Material	25/4	25/4	25/5
Price in €/pcs	With VAT	With VAT	With VAT
TM 1 Testa di Moro RAL 8028	3,78 095435	4,02 095442	4,26 095459
AN 2 Anthracite RAL 7016	3,78 095312	4,02 095329	4,26 095336
IC 3 Intense black RAL 9005	3,78 095374	4,02 095381	4,26 095398
MH 5 Copper brown RAL 8004	3,78 095404	4,02 095411	4,26 095428
BH 7 White aluminum RAL 9006	3,78 095343 *	4,02 095350	4,26 095367
Package in pcs 	25	25	25
Package in pcs 	1 000	1 000	1 000



* Custom production



GALVANIZED STEEL POLYESTER

ON-ROOF GUTTER HOOK WITH SUPPORT

P-PHSSN

Nominal dimension	4
Material	20/6
Price in €/pcs	With VAT
TM 1 Testa di Moro RAL 8028	10,32 033567
AN 2 Anthracite RAL 7016	10,32 033468
IC 3 Intense black RAL 9005	10,32 033482
OC 4 Steel red RAL 3009	10,32 033536
MH 5 Copper brown RAL 8004	10,32 033499
SB 6 Grey white RAL 9002	10,32 033550
BH 7 White aluminum RAL 9006	10,32 033475
PS 8 Dusty grey RAL 7037	10,32 033543
MM 9 Metallic copper RAL extra	10,32 033505
BHT – P.20 10 Grey aluminum RAL 9007	10,32 095510 *
MZ 11 Moss green RAL 6005	10,32 033529
MOT 12 Gentian blue RAL 5010	10,32 033512 *
TZ 13 Reseda green RAL 6011	10,32 033574
Package in pcs 	25
Package in pcs 	1 000

* Custom production

GALV. STEEL
POLYESTER



GALVANIZED STEEL POLYESTER

HOOK FASCIA

P-PHPK



Nominal dimension	200	250	280	333	400
Material	25/4	25/4	25/4	25/5	30/5
Price in €/pcs	With VAT	With VAT	With VAT	With VAT	With VAT
TM 1 Testa di Moro RAL 8028	4,32	4,08	4,38	4,74	6,60
	065551	065568	065575	065582	065599
AN 2 Anthracite RAL 7016	4,32	4,08	4,38	4,74	6,60
	065056	065063	065070	065087	065094
IC 3 Intense black RAL 9005	4,32	4,08	4,38	4,74	6,60
	065155	065162	065179	065186	065193 *
OC 4 Steel red RAL 3009	4,32	4,08	4,38	4,74	6,60
	065407	065414	065421	065438	065445
MH 5 Copper brown RAL 8004	4,32	4,08	4,38	4,74	6,60
	065209	065216	065223	065230	065247 *
SB 6 Grey white RAL 9002	4,32	4,08	4,38	4,74	6,60
	065506	065513	065520	065537	065544
BH 7 White aluminum RAL 9006	4,32	4,08	4,38	4,74	6,60
	065100	065117	065124	065131	065148
PS 8 Dusty grey RAL 7037	4,32	4,08	4,38	4,74	6,60
	065452	065469	065476	065483	065490
MM 9 Metallic copper RAL extra	4,32	4,08	4,38	4,74	6,60
	065254	065261	065278	065285	065292 *
BHT – P.20 10 Grey aluminum RAL 9007		4,08	4,38	4,74	
		095251	095268	095275	
MZ 11 Moss green RAL 6005	4,32	4,08	4,38	4,74	6,60
	065353	065360	065377	065384	065391 *
MOT 12 Gentian blue RAL 5010	4,32	4,08	4,38	4,74	6,60
	065308 *	065315	065322	065339	065346
TZ 13 Reseda green RAL 6011	4,32	4,08	4,38	4,74	6,60
	065605 *	065612 *	065629 *	065636 *	065643 *
Package in pcs	25	25	25	25	20
Package in pcs	1 000	1 000	1 000	1 000	800

* Custom production

GALVANIZED STEEL POLYESTER

CORNER OUTER

P-PRA

Nominal dimension	200	250	280	333	400
Price in €/pcs	With VAT	With VAT	With VAT	With VAT	With VAT
TM 1 Testa di Moro RAL 8028	14,28	14,04	14,16	14,28	35,88
	075673	075680	075697	075703	075710
AN 2 Anthracite RAL 7016	14,28	14,04	14,16	14,28	35,88
	075178	075185	075192	075208	075215
IC 3 Intense black RAL 9005	14,28	14,04	14,16	14,28	35,88
	075260	075284	075291	075307	075314
OC 4 Steel red RAL 3009	14,28	14,04	14,16	14,28	35,88
	075529	075536	075543	075567	075550
MH 5 Copper brown RAL 8004	14,28	14,04	14,16	14,28	35,88
	075321	075338	075345	075352	075369
SB 6 Grey white RAL 9002	14,28	14,04	14,16	14,28	35,88
	075635	075628	075642	075659	075666
BH 7 White aluminum RAL 9006	14,28	14,04	14,16	14,28	35,88
	075222	075239	075246	075253	075277
PS 8 Dusty grey RAL 7037	14,28	14,04	14,16	14,28	35,88
	075574	075581	075598	075604	075611
MM 9 Metallic copper RAL extra	14,28	14,04	14,16	14,28	35,88
	075376	075383	075390	075406	075413
BHT – P.20 10 Grey aluminum RAL 9007		14,04	14,16	14,28	35,88
		094384	094391 *	094407	110695
MZ 11 Moss green RAL 6005	14,28	14,04	14,16	14,28	35,88
	075475	075482	075499	075505	075512
MOT 12 Gentian blue RAL 5010	14,28	14,04	14,16	14,28	35,88
	075420	075437	075444	075451	075468
TZ 13 Reseda green RAL 6011	14,28	14,04	14,16	14,28	35,88
	075727 *	075734	075741	075758	075765 *
Package in pcs	5	5	5	5	5
Package in pcs	150	150	150	150	150

* Custom production



GALV. STEEL
POLYESTER

CORNER INNER

P-PRI

Nominal dimension	200	250	280	333	400
Price in €/pcs	With VAT	With VAT	With VAT	With VAT	With VAT
TM 1 Testa di Moro RAL 8028	14,28	14,04	14,16	14,28	35,88
	076281	076274	076298	076304	076311
AN 2 Anthracite RAL 7016	14,28	14,04	14,16	14,28	35,88
	075772	075789	075796	075802	075819
IC 3 Intense black RAL 9005	14,28	14,04	14,16	14,28	35,88
	075871	075888	075895	075901	075918
OC 4 Steel red RAL 3009	14,28	14,04	14,16	14,28	35,88
	076120	076137	076144	076168	076151
MH 5 Copper brown RAL 8004	14,28	14,04	14,16	14,28	35,88
	075925	075932	075949	075956	075963
SB 6 Grey white RAL 9002	14,28	14,04	14,16	14,28	35,88
	076229	076236	076243	076250	076267
BH 7 White aluminum RAL 9006	14,28	14,04	14,16	14,28	35,88
	075826	075833	075840	075857	075864
PS 8 Dusty grey RAL 7037	14,28	14,04	14,16	14,28	35,88
	076175	076199	076182	076205	076212
MM 9 Metallic copper RAL extra	14,28	14,04	14,16	14,28	35,88
	075970	075987	075994	076007	076014
BHT – P.20 10 Grey aluminum RAL 9007		14,04	14,16	14,28	35,88
		094414	094421 *	094438	110688
MZ 11 Moss green RAL 6005	14,28	14,04	14,16	14,28	35,88
	076076	076083	076090	076106	076113
MOT 12 Gentian blue RAL 5010	14,28	14,04	14,16	14,28	35,88
	076021 *	076038	076045	076052	076069
TZ 13 Reseda green RAL 6011	14,28	14,04	14,16	14,28	35,88
	076335 *	076328	076342	076359	076366 *
Package in pcs	5	5	5	5	5
Package in pcs	150	150	150	150	150

* Custom production

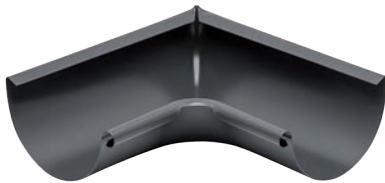

GALVANIZED STEEL POLYESTER

END CAP

P-PCL

Nominal dimension	200	250	280	333	400
Price in €/pcs	With VAT	With VAT	With VAT	With VAT	With VAT
TM 1 Testa di Moro RAL 8028	1,74	1,56	1,68	1,74	2,70
	003164	003171	003188	003195	003201
AN 2 Anthracite RAL 7016	1,74	1,56	1,68	1,74	2,70
	002662	002679	002686	002693	002709
IC 3 Intense black RAL 9005	1,74	1,56	1,68	1,74	2,70
	002761	002778	002785	002792	002808
OC 4 Steel red RAL 3009	1,74	1,56	1,68	1,74	2,70
	003010	003027	003034	003041	003058
MH 5 Copper brown RAL 8004	1,74	1,56	1,68	1,74	2,70
	002815	002822	002839	002846	002853
SB 6 Grey white RAL 9002	1,74	1,56	1,68	1,74	2,70
	003119	003126	003133	003140	003157
BH 7 White aluminum RAL 9006	1,74	1,56	1,68	1,74	2,70
	002716	002723	002730	002747	002754
PS 8 Dusty grey RAL 7037	1,74	1,56	1,68	1,74	2,70
	003065	003072	003089	003096	003102
MM 9 Metallic copper RAL extra	1,74	1,56	1,68	1,74	2,70
	002860	002877	002884	002891	002907
BHT – P.20 10 Grey aluminum RAL 9007		1,56	1,68	1,74	2,70
		094568	094575 *	094582	094599
MZ 11 Moss green RAL 6005	1,74	1,56	1,68	1,74	2,70
	002969	002976	002983	002990	003003
MOT 12 Gentian blue RAL 5010	1,74	1,56	1,68	1,74	2,70
	002914	002921	002938	002945	002952
TZ 13 Reseda green RAL 6011	1,74	1,56	1,68	1,74	2,70
	003218 *	003225	003232	003249	003256
Package in pcs	6/60	6/60	6/60	6/60	4/40
Package in pcs	1 440	1 440	1 440	1 440	960

* Custom production



GALV. STEEL
POLYESTER

GALVANIZED STEEL POLYESTER

END CAP WITH RUBBER SEAL

P-PCLG

Nominal dimension	250	280	333
Price in €/pcs	With VAT	With VAT	With VAT
TM 1 Testa di Moro RAL 8028	3,18 004338	3,48 004345	3,60 004352
AN 2 Anthracite RAL 7016	3,18 004031	3,48 004048	3,60 004055
IC 3 Intense black RAL 9005	3,18 004093	3,48 004109	3,60 004116
OC 4 Steel red RAL 3009	3,18 004246	3,48 004253	3,60 004260
MH 5 Copper brown RAL 8004	3,18 004123	3,48 004130	3,60 004147
SB 6 Grey white RAL 9002	3,18 004307	3,48 004314	3,60 004321
BH 7 White aluminum RAL 9006	3,18 004062	3,48 004079	3,60 004086
PS 8 Dusty grey RAL 7037	3,18 004277	3,48 004284	3,60 004291
MM 9 Metallic copper RAL extra	3,18 004154	3,48 004161	3,60 004178
BHT – P.20 10 Grey aluminum RAL 9007	3,18 094605	3,48 094612 *	3,60 094629
MZ 11 Moss green RAL 6005	3,18 004215	3,48 004222	3,60 004239
MOT 12 Gentian blue RAL 5010	3,18 004185	3,48 004192	3,60 004208
TZ 13 Reseda green RAL 6011	3,18 004369 *	3,48 004376 *	3,60 004383 *
Package in pcs 	4/40	4/40	4/40
Package in pcs 	960	960	960

* Custom production



GALVANIZED STEEL POLYESTER

OUTLET

P-PKL

Nominal dimension	200/60	250/60	250/80	280/80	280/100
Price in €/pcs	With VAT	With VAT	With VAT	With VAT	With VAT
TM 1 Testa di Moro RAL 8028	8,88	10,80	7,92	8,64	8,64
	067357	067364	067371	067388	067395
AN 2 Anthracite RAL 7016	8,88	10,80	7,92	8,64	8,64
	066251	066268	066275	066282	066299
IC 3 Intense black RAL 9005	8,88	10,80	7,92	8,64	8,64
	066473	066480	066497	066503	066510
OC 4 Steel red RAL 3009	8,88	10,80	7,92	8,64	8,64
	067029	067036	067043	067050	067067
MH 5 Copper brown RAL 8004	8,88	10,80	7,92	8,64	8,64
	066589	066596	066602	066619	066626
SB 6 Grey white RAL 9002	8,88	10,80	7,92	8,64	8,64
	067241	067258	067265	067272	067289
BH 7 White aluminum RAL 9006	8,88	10,80	7,92	8,64	8,64
	066367	066374	066381	066398	066404
PS 8 Dusty grey RAL 7037	8,88	10,80	7,92	8,64	8,64
	067135	067142 *	067159	067166	067173
MM 9 Metallic copper RAL extra	8,88	10,80	7,92	8,64	8,64
	066695	066701 *	066718	066725	066732
BHT – P.20 10 Grey aluminum RAL 9007	8,88	10,80	7,92	8,64	8,64
	119728 *	119735 *	094469	094476	094483
MZ 11 Moss green RAL 6005	8,88	10,80	7,92	8,64	8,64
	066916	066923	066930	066947	066954
MOT 12 Gentian blue RAL 5010	8,88	10,80	7,92	8,64	8,64
	066800 *	066817 *	066824	066831	066848
TZ 13 Reseda green RAL 6011	8,88	10,80	7,92	8,64	8,64
	067463 *	067470 *	067487	067494 *	067500
Package in pcs 	20	20	20	20	20
Package in pcs 	600	600	600	600	600

* Custom production



GALV. STEEL
POLYESTER

GALVANIZED STEEL POLYESTER

OUTLET

P-PKL



Nominal dimension	333/80	333/100	333/120
Price in €/pcs	With VAT	With VAT	With VAT
TM 1 Testa di Moro RAL 8028	10,08 067401	9,54 067418	11,40 067425
AN 2 Anthracite RAL 7016	10,08 066305	9,54 066312	11,40 066329
IC 3 Intense black RAL 9005	10,08 066527	9,54 066534	11,40 066541
OC 4 Steel red RAL 3009	10,08 067074	9,54 067081	11,40 067098
MH 5 Copper brown RAL 8004	10,08 066633	9,54 066640	11,40 066657
SB 6 Grey white RAL 9002	10,08 067296	9,54 067302	11,40 067326
BH 7 White aluminum RAL 9006	10,08 066411	9,54 066428	11,40 066435
PS 8 Dusty grey RAL 7037	10,08 067180	9,54 067197	11,40 067203
MM 9 Metallic copper RAL extra	10,08 066749	9,54 066756	11,40 066763
BHT – P.20 10 Grey aluminum RAL 9007	10,08 094490 *	9,54 094506	11,40 094513
MZ 11 Moss green RAL 6005	10,08 066961	9,54 066978	11,40 066985
MOT 12 Gentian blue RAL 5010	10,08 066855 *	9,54 066862	11,40 066879
TZ 13 Reseda green RAL 6011	10,08 067517 *	9,54 067524	11,40 067531
Package in pcs	20	20	15
Package in pcs	600	600	300

* Custom production

GALVANIZED STEEL POLYESTER

OUTLET

P-PKL

Nominal dimension	400/100	400/120	400/150
Price in €/pcs	With VAT	With VAT	With VAT
TM 1 Testa di Moro RAL 8028	22,80 067432	22,80 067449	25,80 067456
AN 2 Anthracite RAL 7016	22,80 066336	22,80 066343	25,80 066350
IC 3 Intense black RAL 9005	22,80 066558	22,80 066565	25,80 066572
OC 4 Steel red RAL 3009	22,80 067104 *	22,80 067111	25,80 067128
MH 5 Copper brown RAL 8004	22,80 066664 *	22,80 066671	25,80 066688
SB 6 Grey white RAL 9002	22,80 067319	22,80 067333	25,80 067340
BH 7 White aluminum RAL 9006	22,80 066442	22,80 066459	25,80 066466
PS 8 Dusty grey RAL 7037	22,80 067210	22,80 067227	25,80 067234
MM 9 Metallic copper RAL extra	22,80 066770 *	22,80 066787 *	25,80 066794 *
BHT – P.20 10 Grey aluminum RAL 9007	22,80 119742 *	22,80 094520	25,80 094667
MZ 11 Moss green RAL 6005	22,80 066992 *	22,80 067005	25,80 067012
MOT 12 Gentian blue RAL 5010	22,80 066886 *	22,80 066893	25,80 066909
TZ 13 Reseda green RAL 6011	22,80 067548 *	22,80 067555	25,80 067562 *
Package in pcs 	15	15	15
Package in pcs 	300	300	300

* Custom production



GALV. STEEL
POLYESTER

GALVANIZED STEEL POLYESTER



NEW CLAMPING SYSTEM FEDER ENABLES TO TURN THE ELBOW EASY IN THE DESIRED DIRECTION AND HOLDS RELIABLY IN ANY POSITION. EASY INSTALLATION TO ANY ELBOW WITHOUT RIVETING.



GALVANIZED STEEL POLYESTER

GUTTER OUTLET NECK

P-PHRD

Nominal dimension	80	100	120
Price in €/pcs	With VAT	With VAT	With VAT
TM 1 Testa di Moro RAL 8028	1,98	2,10	2,52
	066015	066022	066039
AN 2 Anthracite RAL 7016	1,98	2,10	2,52
	065711	065728	065735 *
IC 3 Intense black RAL 9005	1,98	2,10	2,52
	065773 *	065780	065797 *
OC 4 Steel red RAL 3009	1,98	2,10	2,52
	065926 *	065933	065940 *
MH 5 Copper brown RAL 8004	1,98	2,10	2,52
	065803 *	065810	065827 *
SB 6 Grey white RAL 9002	1,98	2,10	2,52
	065988 *	065995 *	066008 *
BH 7 White aluminum RAL 9006	1,98	2,10	2,52
	065742 *	065759 *	065766 *
PS 8 Dusty grey RAL 7037	1,98	2,10	2,52
	065957 *	065964 *	065971 *
MM 9 Metallic copper RAL extra	1,98	2,10	2,52
	065834 *	065841 *	065858 *
BHT – P.20 10 Grey aluminum RAL 9007			
MZ 11 Moss green RAL 6005	1,98	2,10	2,52
	065896 *	065902 *	065919 *
MOT 12 Gentian blue RAL 5010	1,98	2,10	2,52
	065865 *	065872 *	065889 *
TZ 13 Reseda green RAL 6011	1,98	2,10	2,52
	066046 *	066053 *	066060 *
Package in pcs 	25	25	15
Package in pcs 	1 000	1 000	750

* Custom production





GALV. STEEL
POLYESTER

GALVANIZED STEEL POLYESTER

STAINLESS STEEL LEAF SIEVE

N-NZN



Nominal dimension	EAN product number	Packaging in pcs		Price with VAT [€/pcs]
				
60	001153	30	2 160	6,66
80	001160	20	1 440	6,72
100	001177	15	1 080	6,84
120	001184	10	720	7,44
150	001191	5	360	11,76



GALVANIZED STEEL POLYESTER

HOPPER DESIGN

P-PKLZ DE

Nominal dimension	80	100	120
Price in €/pcs	With VAT	With VAT	With VAT
TM 1 Testa di Moro RAL 8028	69,60 027702	69,60 027726	76,80 027740
AN 2 Anthracite RAL 7016	69,60 026200	69,60 026224	76,80 026248
IC 3 Intense black RAL 9005	69,60 026507	69,60 026521	76,80 026545
OC 4 Steel red RAL 3009	69,60 027252 *	69,60 027276	76,80 027290
MH 5 Copper brown RAL 8004	69,60 026651	69,60 026675	76,80 026699
SB 6 Grey white RAL 9002	69,60 027559 *	69,60 027573	76,80 027597
BH 7 White aluminum RAL 9006	69,60 026354	69,60 026378	76,80 026392
PS 8 Dusty grey RAL 7037	69,60 027405	69,60 027429	76,80 027443
MM 9 Metallic copper RAL extra	69,60 026804 *	69,60 026828	76,80 026842
BHT – P.20 10 Grey aluminum RAL 9007	69,60 096210	69,60 096265	76,80 096319
MZ 11 Moss green RAL 6005	69,60 027108 *	69,60 027122	76,80 027146 *
MOT 12 Gentian blue RAL 5010	69,60 026958 *	69,60 026972	76,80 027009 *
TZ 13 Reseda green RAL 6011	69,60 027856 *	69,60 027870 *	76,80 027894 *
Package in pcs 	2	2	2
Package in pcs 	36	36	36

* Custom production



GALV. STEEL
POLYESTER

GALVANIZED STEEL POLYESTER

HOPPER DESIGN ECCENTRIC

P-PKLZ DX



Nominal dimension	80	100	120
Price in €/pcs	With VAT	With VAT	With VAT
TM 1 Testa di Moro RAL 8028	86,40 027764	86,40 027795	88,80 027825
AN 2 Anthracite RAL 7016	86,40 026262	86,40 026293	88,80 026323
IC 3 Intense black RAL 9005	86,40 026569	86,40 026590	88,80 026620 *
OC 4 Steel red RAL 3009	86,40 027313	86,40 027344	88,80 027375 *
MH 5 Copper brown RAL 8004	86,40 026712 *	86,40 026743 *	88,80 026774 *
SB 6 Grey white RAL 9002	86,40 027610 *	86,40 027641	88,80 027672
BH 7 White aluminum RAL 9006	86,40 026415 *	86,40 026446	88,80 026477
PS 8 Dusty grey RAL 7037	86,40 027467 *	86,40 027498	88,80 027528
MM 9 Metallic copper RAL extra	86,40 026866 *	86,40 026897	88,80 026927 *
BHT – P.20 10 Grey aluminum RAL 9007	86,40 096203 *	86,40 096258	88,80 096302
MZ 11 Moss green RAL 6005	86,40 027160 *	86,40 027191 *	88,80 027221 *
MOT 12 Gentian blue RAL 5010	86,40 027016 *	86,40 027047 *	88,80 027078 *
TZ 13 Reseda green RAL 6011	86,40 027917 *	86,40 027948 *	88,80 027979 *
Package in pcs 	2	2	2
Package in pcs 	36	36	36

* Custom production

GALVANIZED STEEL POLYESTER

HOPPER CUBIC

P-PKLZ KU



Nominal dimension	80	100	120
Price in €/pcs	With VAT	With VAT	With VAT
TM 1 Testa di Moro RAL 8028	105,60 027719 *	105,60 027733	112,80 027757
AN 2 Anthracite RAL 7016	105,60 026217	105,60 026231	112,80 026255
IC 3 Intense black RAL 9005	105,60 026514	105,60 026538	112,80 026552
OC 4 Steel red RAL 3009	105,60 027269 *	105,60 027283 *	112,80 027306
MH 5 Copper brown RAL 8004	105,60 026668 *	105,60 026682 *	112,80 026705 *
SB 6 Grey white RAL 9002	105,60 027566 *	105,60 027580 *	112,80 027603 *
BH 7 White aluminum RAL 9006	105,60 026361 *	105,60 026385	112,80 026408
PS 8 Dusty grey RAL 7037	105,60 027412 *	105,60 027436 *	112,80 027450
MM 9 Metallic copper RAL extra	105,60 026811 *	105,60 026835 *	112,80 026859 *
BHT – P.20 10 Grey aluminum RAL 9007	105,60 096241 *	105,60 096296 *	112,80 096340 *
MZ 11 Moss green RAL 6005	105,60 027115 *	105,60 027139 *	112,80 027153 *
MOT 12 Gentian blue RAL 5010	105,60 026965 *	105,60 026989 *	112,80 026996 *
TZ 13 Reseda green RAL 6011	105,60 027863 *	105,60 027887 *	112,80 027900 *
Package in pcs 	2	2	2
Package in pcs 	36	36	36



* Custom production

GALVANIZED STEEL POLYESTER

HOPPER CUBIC ECCENTRIC

P-PKLZ KX



Nominal dimension	80	100	120
Price in €/pcs	With VAT	With VAT	With VAT
TM 1 Testa di Moro RAL 8028	105,60 027788	105,60 027818	112,80 027849
AN 2 Anthracite RAL 7016	105,60 026286	105,60 026316	112,80 026347
IC 3 Intense black RAL 9005	105,60 026583	105,60 026613	112,80 026644 *
OC 4 Steel red RAL 3009	105,60 027337 *	105,60 027368	112,80 027399
MH 5 Copper brown RAL 8004	105,60 026736	105,60 026767	112,80 026798 *
SB 6 Grey white RAL 9002	105,60 027634 *	105,60 027665	112,80 027696
BH 7 White aluminum RAL 9006	105,60 026439 *	105,60 026460	112,80 026491
PS 8 Dusty grey RAL 7037	105,60 027481 *	105,60 027511	112,80 027542
MM 9 Metallic copper RAL extra	105,60 026880 *	105,60 026910	112,80 026941 *
BHT – P.20 10 Grey aluminum RAL 9007	105,60 096227	105,60 096272	112,80 096326
MZ 11 Moss green RAL 6005	105,60 027184 *	105,60 027214	112,80 027245 *
MOT 12 Gentian blue RAL 5010	105,60 027030 *	105,60 027061 *	112,80 027092 *
TZ 13 Reseda green RAL 6011	105,60 027931 *	105,60 027962	112,80 027993 *
Package in pcs 	2	2	2
Package in pcs 	36	36	36

* Custom production

GALVANIZED STEEL POLYESTER

HOPPER CUBIC ECCENTRIC WITH OVERFLOW PIPE

P-PKLZ KXV





Nominal dimension	80	100	120
Price in €/pcs	With VAT	With VAT	With VAT
TM 1 Testa di Moro RAL 8028	138,00 027771 *	138,00 027801 *	138,00 027832 *
AN 2 Anthracite RAL 7016	138,00 026279 *	138,00 026309 *	138,00 026330 *
IC 3 Intense black RAL 9005	138,00 026576 *	138,00 026606	138,00 026637 *
OC 4 Steel red RAL 3009	138,00 027320 *	138,00 027351 *	138,00 027382 *
MH 5 Copper brown RAL 8004	138,00 026729 *	138,00 026750 *	138,00 026781 *
SB 6 Grey white RAL 9002	138,00 027627 *	138,00 027658 *	138,00 027689 *
BH 7 White aluminum RAL 9006	138,00 026422 *	138,00 026453 *	138,00 026484 *
PS 8 Dusty grey RAL 7037	138,00 027474 *	138,00 027504 *	138,00 027535 *
MM 9 Metallic copper RAL extra	138,00 026873 *	138,00 026903 *	138,00 026934 *
BHT – P.20 10 Grey aluminum RAL 9007	138,00 096234 *	138,00 096289 *	138,00 096333 *
MZ 11 Moss green RAL 6005	138,00 027177 *	138,00 027207 *	138,00 027238 *
MOT 12 Gentian blue RAL 5010	138,00 027023 *	138,00 027054 *	138,00 027085 *
TZ 13 Reseda green RAL 6011	138,00 027924 *	138,00 027955 *	138,00 027986 *
Package in pcs 	2	2	2
Package in pcs 	36	36	36

* Custom production

RUBBER SEAL FOR HOPPER

P-PKLZ T



Nominal dimension	EAN product number	Packaging in pcs		Price with VAT [€/pcs]
				
IC 70-85	077103	5	600	4,80
IC 100-110	077110	5	600	4,92
IC 110-125	077097	5	600	5,04
PS 70-85	077134	5	600	5,40
PS 100-110	077141	5	600	5,88
PS 110-125	077127	5	600	6,00

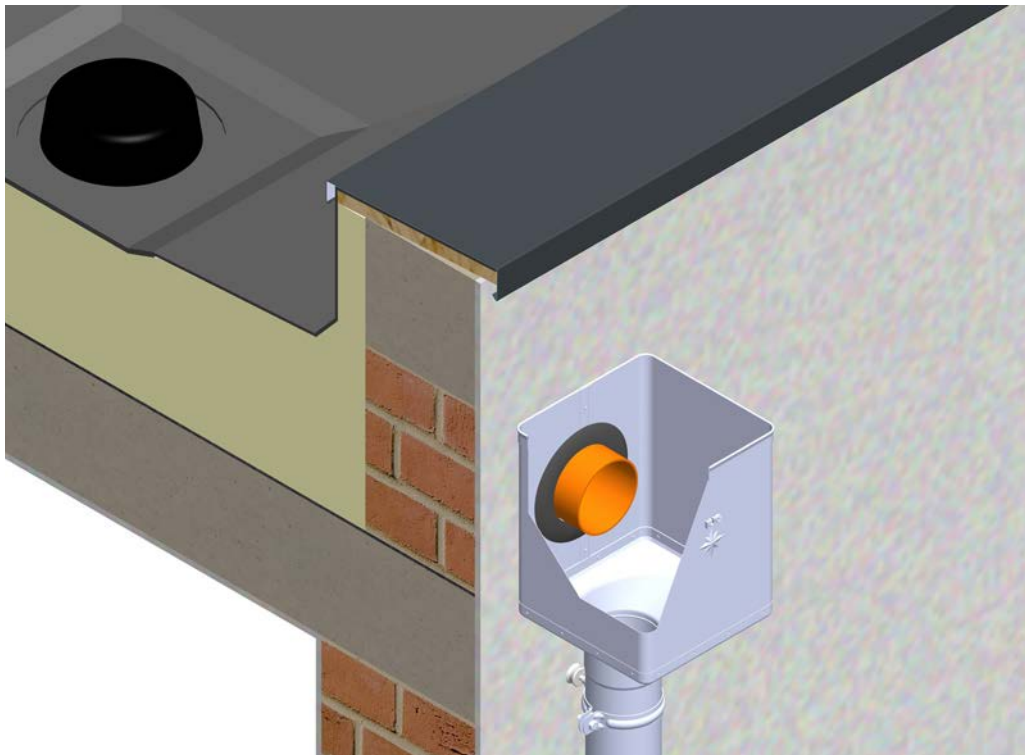

GALVANIZED STEEL POLYESTER

ELBOW FOLDED 72°

P-PK

Nominal dimension	60	80	100	120	150
Price in €/pcs	With VAT	With VAT	With VAT	With VAT	With VAT
TM 1 Testa di Moro RAL 8028	7,20	6,60	7,20	10,20	23,94
	072542	072559	072573	072597	033697
AN 2 Anthracite RAL 7016	7,20	6,60	7,20	10,20	23,94
	071842	071859	071873	071897	033598
IC 3 Intense black RAL 9005	7,20	6,60	7,20	10,20	23,94
	071989	072023	072009	072030	033611
OC 4 Steel red RAL 3009	7,20	6,60	7,20	10,20	23,94
	072337	072344	072368	072382	033666
MH 5 Copper brown RAL 8004	7,20	6,60	7,20	10,20	23,94
	072054	072061	072085	072108	033628
SB 6 Grey white RAL 9002	7,20	6,60	7,20	10,20	23,94
	072474	072481	072504	072528	033680
BH 7 White aluminum RAL 9006	7,20	6,60	7,20	10,20	23,94
	071910	071927	071941	071965	033604
PS 8 Dusty grey RAL 7037	7,20	6,60	7,20	10,20	23,94
	072405	072412	072429	072443	033673
MM 9 Metallic copper RAL extra	7,20	6,60	7,20	10,20	23,94
	072122	072139	072153	072160	033635
BHT – P.20 10 Grey aluminum RAL 9007	7,20	6,60	7,20	10,20	23,94
	118691 *	095183	095206	095220	095244
MZ 11 Moss green RAL 6005	7,20	6,60	7,20	10,20	23,94
	072269	072276	072290	072313	033659
MOT 12 Gentian blue RAL 5010	7,20	6,60	7,20	10,20	23,94
	072191	072207	072221	072245	033642
TZ 13 Reseda green RAL 6011	7,20	6,60	7,20	10,20	23,94
	072610 *	072627	072641	072665	033703 *
Package in pcs 	25	25	25	15	5
Package in pcs 	600	400	300	180	90

* Custom production



GALV. STEEL
POLYESTER

GALVANIZED STEEL POLYESTER

ELBOW FOLDED 85°

P-PKR

Nominal dimension	80	100	120
Price in €/pcs	With VAT	With VAT	With VAT
TM 1 Testa di Moro RAL 8028	8,28 072566	9,36 072580	14,88 072603
AN 2 Anthracite RAL 7016	8,28 071866	9,36 071880	14,88 071903
IC 3 Intense black RAL 9005	8,28 071996	9,36 072016	14,88 072047
OC 4 Steel red RAL 3009	8,28 072351	9,36 072375	14,88 072399
MH 5 Copper brown RAL 8004	8,28 072078	9,36 072092	14,88 072115
SB 6 Grey white RAL 9002	8,28 072498	9,36 072511	14,88 072535
BH 7 White aluminum RAL 9006	8,28 071934	9,36 071958	14,88 071972
PS 8 Dusty grey RAL 7037	8,28 072467	9,36 072436	14,88 072450
MM 9 Metallic copper RAL extra	8,28 072146	9,36 072184	14,88 072177
BHT – P.20 10 Grey aluminum RAL 9007	8,28 095190	9,36 095213	14,88 095237 *
MZ 11 Moss green RAL 6005	8,28 072283	9,36 072306	14,88 072320
MOT 12 Gentian blue RAL 5010	8,28 072214 *	9,36 072238 *	14,88 072252 *
TZ 13 Reseda green RAL 6011	8,28 072634 *	9,36 072658 *	14,88 072672 *
Package in pcs	25	25	15
Package in pcs	400	300	180

* Custom production



GALVANIZED STEEL POLYESTER

ELBOW BLIND 40°

P-PKT

Nominal dimension	80	100	120
Price in €/pcs	With VAT	With VAT	With VAT
TM 1 Testa di Moro RAL 8028	7,80 072993	8,52 073006	12,00 073013
AN 2 Anthracite RAL 7016	7,80 072696	8,52 072702	12,00 072719
IC 3 Intense black RAL 9005	7,80 072757	8,52 072764	12,00 072771
OC 4 Steel red RAL 3009	7,80 072900	8,52 072917	12,00 072924
MH 5 Copper brown RAL 8004	7,80 072795	8,52 072788	12,00 072801
SB 6 Grey white RAL 9002	7,80 072962	8,52 072979	12,00 072986
BH 7 White aluminum RAL 9006	7,80 072726	8,52 072733	12,00 072740
PS 8 Dusty grey RAL 7037	7,80 072931	8,52 072948	12,00 072955
MM 9 Metallic copper RAL extra	7,80 072818	8,52 072825	12,00 072832 *
BHT – P.20 10 Grey aluminum RAL 9007	7,80 094711	8,52 094728	12,00 094735
MZ 11 Moss green RAL 6005	7,80 072870 *	8,52 072887	12,00 072894
MOT 12 Gentian blue RAL 5010	7,80 072849	8,52 072856	12,00 072863
TZ 13 Reseda green RAL 6011	7,80 073020 *	8,52 073037 *	12,00 073044 *
Package in pcs	25	25	15
Package in pcs	400	300	240

* Custom production

GALV. STEEL
POLYESTER



GALVANIZED STEEL POLYESTER

DOWNSPOUT ELBOW 72°

P-PKV



Nominal dimension	80	100	120
Price in €/pcs	With VAT	With VAT	With VAT
TM 1 Testa di Moro RAL 8028	7,80 095046	8,40 095053	11,40 095060
AN 2 Anthracite RAL 7016	7,80 094742	8,40 094759	11,40 094766
IC 3 Intense black RAL 9005	7,80 094803	8,40 094810	11,40 094827 *
OC 4 Steel red RAL 3009	7,80 094957 *	8,40 094964	11,40 094971 *
MH 5 Copper brown RAL 8004	7,80 094834	8,40 094841	11,40 094858
SB 6 Grey white RAL 9002	7,80 095015 *	8,40 095022	11,40 095039
BH 7 White aluminum RAL 9006	7,80 094773 *	8,40 094780	11,40 094797
PS 8 Dusty grey RAL 7037	7,80 094988 *	8,40 094995 *	11,40 095008 *
MM 9 Metallic copper RAL extra	7,80 094865 *	8,40 094872 *	11,40 094889 *
BHT – P.20 10 Grey aluminum RAL 9007	7,80 124739 *	8,40 124746 *	11,40 124753 *
MZ 11 Moss green RAL 6005	7,80 094926 *	8,40 094933 *	11,40 094940 *
MOT 12 Gentian blue RAL 5010	7,80 094896 *	8,40 094902 *	11,40 094919 *
TZ 13 Reseda green RAL 6011	7,80 095077 *	8,40 095084 *	11,40 095091 *
Package in pcs	25	25	15
Package in pcs	400	300	180



* Custom production

GALVANIZED STEEL POLYESTER

ELBOW FOLDED 72°

P-PKF2





Nominal dimension	60	80	100	120
Price in €/pcs	With VAT	With VAT	With VAT	With VAT
TM 1 Testa di Moro RAL 8028	5,16	4,08	5,28	7,56
	071781	071798	071811	071828
Package in pcs 	10	10	10	8
Package in pcs 	3 000	1 200	800	576

ELBOW FOLDED 85°

P-PKF3





Nominal dimension	80	100
Price in €/pcs	With VAT	With VAT
TM 1 Testa di Moro RAL 8028	5,28	7,56
	071804	071835
Package in pcs 	10	10
Package in pcs 	1 200	800

PLASTIC DOWNPIPE SLEEVE

SD-ZR FOLIA KJG



Nominal dimension	Lenght in m	EAN product number	Packaging in m		Cena with VAT [€/m]
					
60-150	100,0	139726	100	6 000	0,46

GALVANIZED STEEL POLYESTER

DOWNPIPE [s=0,55]

P-PZR



Nominal dimension	60	60	80	80	80
Length in m	2,0	3,0	1,0	2,0	3,0
Price in €/m	With VAT	With VAT	With VAT	With VAT	With VAT
TM 1 Testa di Moro RAL 8028	9,60	9,60	8,64	8,64	8,40
	071309	071316	071323	071330	071347
AN 2 Anthracite RAL 7016	9,60	9,60	8,64	8,64	8,40
	069467	069474	069481	069498	069504
IC 3 Intense black RAL 9005	9,60	9,60	8,64	8,64	8,40
	069900	069917	069924	069931	069948
OC 4 Steel red RAL 3009	9,60	9,60	8,64	8,64	8,40
	070661	070678	070685	070692	070708
MH 5 Copper brown RAL 8004	9,72		8,76	8,76	8,52
	070128		070142	070159	070166
SB 6 Grey white RAL 9002	9,72	9,72	8,76	8,76	8,52
	071088	071095	071101	071118	071125
BH 7 White aluminum RAL 9006	9,72	9,72	8,76	8,76	8,52
	069689	069696	069702	069719	069726
PS 8 Dusty grey RAL 7037	9,72	9,72	8,76	8,76	8,52
	070883	070890	070906	070913	070920
MM 9 Metallic copper RAL extra	10,20		9,30	9,30	9,06
	070340		070364	070371	070388
BHT – P.20 10 Grey aluminum RAL 9007					10,26
					096128
MZ 11 Moss green RAL 6005	10,20				9,06
	070586				070593
MOT 12 Gentian blue RAL 5010	10,20				9,06
	070494				070500
TZ 13 Reseda green RAL 6011	10,20			9,30	
	071521 *			071538	
Package in m	10	15	10	10	15
Package in m	490	735	100	250	375

* Custom production

GALVANIZED STEEL POLYESTER

DOWNPIPE [s=0,55]

P-PZR

Nominal dimension	80	80	80	100	100
Length in m	4,0	5,0	6,0	1,0	2,0
Price in €/m	With VAT	With VAT	With VAT	With VAT	With VAT
TM 1 Testa di Moro RAL 8028	8,40	8,40	8,40	8,88	8,88
	071354	071361 *	071378 *	071385	071392
AN 2 Anthracite RAL 7016	8,40	8,40	8,40	8,88	8,88
	069511	069528 *	069535 *	069542	069559
IC 3 Intense black RAL 9005	8,40	8,40	8,40	8,88	8,88
	069955	069962 *	069979 *	069986	069993
OC 4 Steel red RAL 3009	8,40	8,40	8,40	8,88	8,88
	070715	070722 *	070739 *	070746	070753
MH 5 Copper brown RAL 8004	8,52	8,52	8,52	9,00	9,00
	070173	070180 *	070197 *	070203	070210
SB 6 Grey white RAL 9002	8,52	8,52	8,52	9,00	9,00
	071132	071149 *	071156 *	071163	071170
BH 7 White aluminum RAL 9006	8,52	8,52	8,52	9,00	9,00
	069733	069740 *	069757 *	069764	069771
PS 8 Dusty grey RAL 7037	8,52	8,52	8,52	9,00	9,00
	070937	070944 *	070951 *	070968	070975
MM 9 Metallic copper RAL extra	9,06		10,08	10,08	11,16
	070395		070401	070418	070418
BHT – P.20 10 Grey aluminum RAL 9007					
MZ 11 Moss green RAL 6005	9,06				
	070609				
MOT 12 Gentian blue RAL 5010					
TZ 13 Reseda green RAL 6011					
Package in m 	20	5	6	10	10
Package in m 	500	625	750	70	160

* Custom production



GALV. STEEL
POLYESTER

GALVANIZED STEEL POLYESTER

DOWNPIPE [s=0,55]

P-PZR





Nominal dimension	100	100	100	100	120
Length in m	3,0	4,0	5,0	6,0	1,0
Price in €/m	With VAT	With VAT	With VAT	With VAT	With VAT
TM 1 Testa di Moro RAL 8028	8,64	8,64	8,64	8,64	12,90
	071408	071415	071422	071439 *	071446
AN 2 Anthracite RAL 7016	8,64	8,64	8,64	8,64	12,90
	069566	069573	069580	069597 *	069603
IC 3 Intense black RAL 9005	8,64	8,64	8,64	8,64	12,90
	070005	070012	070029	070036 *	070043
OC 4 Steel red RAL 3009	8,64	8,64	8,64	8,64	12,90
	070760	070777	070784 *	070791 *	070807
MH 5 Copper brown RAL 8004	8,76	8,76	8,76	8,76	13,02
	070227	070234	070241 *	070258 *	070265
SB 6 Grey white RAL 9002	8,76	8,76	8,76	8,76	13,02
	071187	071194	071200 *	071217 *	071224
BH 7 White aluminum RAL 9006	8,76	8,76	8,76	8,76	13,02
	069788	069795	069801 *	069818 *	069825
PS 8 Dusty grey RAL 7037	8,76	8,76	8,76	8,76	13,02
	070982	070999	071002 *	071019 *	071026
MM 9 Metallic copper RAL extra	9,84	9,84			13,80
	070425	070432			070449
BHT – P.20 10 Grey aluminum RAL 9007	10,56	10,56			
	096135	096142			
MZ 11 Moss green RAL 6005	9,84	9,84			
	070616	070623			
MOT 12 Gentian blue RAL 5010	9,84	9,84			
	070524	070531			
TZ 13 Reseda green RAL 6011	9,84	9,84			
	071545	071552			
Package in m	15	20	5	6	8
Package in m	240	320	400	480	48

* Custom production

GALVANIZED STEEL POLYESTER

DOWNPIPE [s=0,55]

P-PZR

Nominal dimension	120	120	120	120	120
Length in m	2,0	3,0	4,0	5,0	6,0
Price in €/m	With VAT	With VAT	With VAT	With VAT	With VAT
TM 1 Testa di Moro RAL 8028	12,90	12,66	12,66	12,66	12,66
	071453	071460	071477	071484 *	071491 *
AN 2 Anthracite RAL 7016	12,90	12,66	12,66	12,66	12,66
	069610	069627	069634	069641 *	069658 *
IC 3 Intense black RAL 9005	12,90	12,66	12,66	12,66	12,66
	070050	070067	070074	070081 *	070098 *
OC 4 Steel red RAL 3009	12,90	12,66	12,66	12,66	12,66
	070814	070821	070838	070845 *	070852 *
MH 5 Copper brown RAL 8004	13,02	12,78	12,78	12,78	12,78
	070272	070289	070296	070302 *	070319 *
SB 6 Grey white RAL 9002	13,02	12,78	12,78	12,78	12,78
	071231	071248	071255	071262	071279 *
BH 7 White aluminum RAL 9006	13,02	12,78	12,78	12,78	12,78
	069832	069849	069856	069863	069870 *
PS 8 Dusty grey RAL 7037	13,02	12,78	12,78		
	071033	071040	071057		
MM 9 Metallic copper RAL extra	13,80	13,62	13,62		
	070456	070463	070470		
BHT – P.20 10 Grey aluminum RAL 9007		14,46			
		096159			
MZ 11 Moss green RAL 6005		13,62	13,62		
		070630	070647		
MOT 12 Gentian blue RAL 5010		13,62	13,62		
		070548	070555		
TZ 13 Reseda green RAL 6011		13,62	13,62		
		071569	071576		
Package in m 	10	15	20	5	6
Package in m 	120	180	240	300	360

* Custom production



GALV. STEEL
POLYESTER

GALVANIZED STEEL POLYESTER

DOWNPIPE [s=0,55]

P-PZR



Nominal dimension	150	150
Length in m	3,0	4,0
Price in €/m	With VAT	With VAT
TM Testa di Moro RAL 8028	24,72 071507	24,72 071514
AN Anthracite RAL 7016	24,72 069665	24,72 069672
IC Intense black RAL 9005		24,72 070111
OC Steel red RAL 3009		24,72 070876
MH Copper brown RAL 8004	24,84 070326	
SB Grey white RAL 9002	24,84 071286	24,84 071293
BH White aluminum RAL 9006	24,84 069887	24,84 069894
PS Dusty grey RAL 7037	24,84 071064	24,84 071071
MM Metallic copper RAL extra	26,16 070487	
BHT – P.20 Grey aluminum RAL 9007	26,70 096166	
MZ Moss green RAL 6005	26,16 070654	
MOT Gentian blue RAL 5010		26,16 070579
TZ Reseda green RAL 6011	26,16 071583 *	
Package in m	3	4
Package in m	84	112

* Custom production

GALVANIZED STEEL POLYESTER

DOWNPIPE CONNECTOR

P-PSRU

Nominal dimension	80	100	120
Price in €/pcs	With VAT	With VAT	With VAT
TM 1 Testa di Moro RAL 8028	5,10 017581	5,28 017598	5,88 017604
AN 2 Anthracite RAL 7016	5,10 017284	5,28 017291	5,88 017307
IC 3 Intense black RAL 9005	5,10 017345	5,28 017352	5,88 017369
OC 4 Steel red RAL 3009	5,10 017499	5,28 017505	5,88 017512
MH 5 Copper brown RAL 8004	5,10 017376	5,28 017383	5,88 017390
SB 6 Grey white RAL 9002	5,10 017550	5,28 017567	5,88 017574
BH 7 White aluminum RAL 9006	5,10 017314	5,28 017321	5,88 017338
PS 8 Dusty grey RAL 7037	5,10 017529	5,28 017536	5,88 017543
MM 9 Metallic copper RAL extra	5,10 017406	5,28 017413	5,88 017420
BHT – P.20 10 Grey aluminum RAL 9007	5,10 095657 *	5,28 095664	5,88 095671 *
MZ 11 Moss green RAL 6005	5,10 017468 *	5,28 017475	5,88 017482
MOT 12 Gentian blue RAL 5010	5,10 017437 *	5,28 017444	5,88 017451
TZ 13 Reseda green RAL 6011	5,10 017611 *	5,28 017628	5,88 017635 *
Package in pcs	10	10	8
Package in pcs	900	900	720

* Custom production

GALV. STEEL
POLYESTER



GALVANIZED STEEL POLYESTER

DOUBLE ELBOW

P-PKO



Nominal dimension	80	100	120
Price in €/pcs	With VAT	With VAT	With VAT
TM 1 Testa di Moro RAL 8028	11,28 034045	11,64 034052	16,74 034069
AN 2 Anthracite RAL 7016	11,28 033741	11,64 033758	16,74 033765
IC 3 Intense black RAL 9005	11,28 033802	11,64 033819	16,74 033826
OC 4 Steel red RAL 3009	11,28 033956	11,64 033963	16,74 033970
MH 5 Copper brown RAL 8004	11,28 033833	11,64 033840	16,74 033857
SB 6 Grey white RAL 9002	11,28 034014	11,64 034021	16,74 034038
BH 7 White aluminum RAL 9006	11,28 033772	11,64 033789	16,74 033796
PS 8 Dusty grey RAL 7037	11,28 033987	11,64 033994	16,74 034007
MM 9 Metallic copper RAL extra	11,28 033864	11,64 033871	16,74 033888
BHT – P.20 10 Grey aluminum RAL 9007	11,28 095688	11,64 095695	16,74 095701
MZ 11 Moss green RAL 6005	11,28 033925	11,64 033932	16,74 033949
MOT 12 Gentian blue RAL 5010	11,28 033895	11,64 033901	16,74 033918
TZ 13 Reseda green RAL 6011	11,28 034076	11,64 034083	16,74 034090
Package in pcs	20	20	15
Package in pcs	320	240	180

GALV. STEEL
POLYESTER

GALVANIZED STEEL POLYESTER

DOWNPIPE BRANCH 72°

P-PZO

Nominal dimension	80/80	100/60	100/80	100/100
Price in €/pcs	With VAT	With VAT	With VAT	With VAT
TM 1 Testa di Moro RAL 8028	18,78 016157	20,88 016164	20,88 016171	21,60 016188
AN 2 Anthracite RAL 7016	18,78 015259	20,88 015266	20,88 015273	21,60 015280
IC 3 Intense black RAL 9005	18,78 015433	20,88 015440	20,88 015457	21,60 015464
OC 4 Steel red RAL 3009	18,78 015884	20,88 015891	20,88 015907	21,60 015914
MH 5 Copper brown RAL 8004	18,78 015525	20,88 015532 *	20,88 015549	21,60 015556
SB 6 Grey white RAL 9002	18,78 016065	20,88 016072 *	20,88 016089	21,60 016096
BH 7 White aluminum RAL 9006	18,78 015341	20,88 015358 *	20,88 015365	21,60 015372
PS 8 Dusty grey RAL 7037	18,78 015976 *	20,88 015983 *	20,88 015990	21,60 016003
MM 9 Metallic copper RAL extra	18,78 015617	20,88 015624 *	20,88 015631	21,60 015648
BHT – P.20 10 Grey aluminum RAL 9007	18,78 096005 *		20,88 096012 *	21,60 096029 *
MZ 11 Moss green RAL 6005	18,78 015792	20,88 015808 *	20,88 015815	21,60 015822
MOT 12 Gentian blue RAL 5010	18,78 015709 *	20,88 015716 *	20,88 015723 *	21,60 015730
TZ 13 Reseda green RAL 6011	18,78 016249 *	20,88 016256 *	20,88 016263 *	21,60 016270 *
Package in pcs	4	4	4	4
Package in pcs	120	120	120	120

* Custom production



GALV. STEEL
POLYESTER

GALVANIZED STEEL POLYESTER

DOWNPIPE BRANCH 72°

P-PZO



Nominal dimension	120/80	120/100	120/120	150/120	150/150
Price in €/pcs	With VAT	With VAT	With VAT	With VAT	With VAT
TM 1 Testa di Moro RAL 8028	23,76	23,76	23,76	34,56	34,56
	016195	016201	016218	016225 *	016232 *
AN 2 Anthracite RAL 7016	23,76	23,76	23,76	34,56	34,56
	015297	015303	015310	015327 *	015334 *
IC 3 Intense black RAL 9005	23,76	23,76	23,76	34,56	34,56
	015471	015488	015495	015501 *	015518 *
OC 4 Steel red RAL 3009	23,76	23,76	23,76	34,56	34,56
	015921	015938	015945	015952 *	015969 *
MH 5 Copper brown RAL 8004	23,76	23,76	23,76	34,56	34,56
	015563	015570	015587	015594 *	015600 *
SB 6 Grey white RAL 9002	23,76	23,76	23,76	34,56	34,56
	016102	016119	016126	016133 *	016140 *
BH 7 White aluminum RAL 9006	23,76	23,76	23,76	34,56	34,56
	015389	015396	015402	015419 *	015426 *
PS 8 Dusty grey RAL 7037	23,76	23,76	23,76	34,56	34,56
	016010 *	016027	016034	016041 *	016058 *
MM 9 Metallic copper RAL extra	23,76	23,76	23,76	34,56	34,56
	015655 *	015662	015679	015686 *	015693 *
BHT – P.20 10 Grey aluminum RAL 9007	23,76	23,76	23,76		
	096036 *	096043 *	096050 *		
MZ 11 Moss green RAL 6005	23,76	23,76	23,76	34,56	34,56
	015839 *	015846 *	015853 *	015860 *	015877 *
MOT 12 Gentian blue RAL 5010	23,76	23,76	23,76	34,56	34,56
	015747 *	015754 *	015761 *	015778 *	015785 *
TZ 13 Reseda green RAL 6011	23,76	23,76	23,76	34,56	34,56
	016287 *	016294 *	016300 *	016317 *	016324 *
Package in pcs 📦	3	3	3	2	2
Package in pcs 🚚	90	90	90	36	36

* Custom production

GALVANIZED STEEL POLYESTER

WATER DISTRIBUTORS

P-PRV

GALV. STEEL
POLYESTER



Nominal dimension	80	100	120
Price in €/pcs	With VAT	With VAT	With VAT
TM 1 Testa di Moro RAL 8028	234,00	239,88	310,80
	088413 *	088420	088437 *
AN 2 Anthracite RAL 7016	234,00	239,88	310,80
	088116 *	088123	088130 *
IC 3 Intense black RAL 9005	234,00	239,88	310,80
	088178 *	088185 *	088192 *
OC 4 Steel red RAL 3009	234,00	239,88	310,80
	088321 *	088338 *	088345 *
MH 5 Copper brown RAL 8004	234,00	239,88	310,80
	088208 *	088215 *	088222 *
SB 6 Grey white RAL 9002	234,00	239,88	310,80
	088383 *	088390 *	088406 *
BH 7 White aluminum RAL 9006	234,00	239,88	310,80
	088147 *	088154 *	088161 *
PS 8 Dusty grey RAL 7037	234,00	239,88	310,80
	088352 *	088369 *	088376 *
MM 9 Metallic copper RAL extra	234,00	239,88	310,80
	088239 *	088246 *	088253 *
BHT – P.20 10 Grey aluminum RAL 9007	234,00	239,88	310,80
	095756 *	095763 *	095770 *
MZ 11 Moss green RAL 6005	234,00	239,88	310,80
	088291 *	088307 *	088314 *
MOT 12 Gentian blue RAL 5010	234,00	239,88	310,80
	088260 *	088277 *	088284 *
TZ 13 Reseda green RAL 6011	234,00	239,88	310,80
	088444 *	088451 *	088468 *
Package in pcs	1	1	1
Package in pcs	–	–	–



* Custom production

GALVANIZED STEEL POLYESTER

DOWNPIPE BRACKET WITH PIN 150 mm

P-PO





Nominal dimension	80	100	120
Price in €/pcs	With VAT	With VAT	With VAT
TM 1 Testa di Moro RAL 8028	3,96 002136	4,02 002143	4,80 002150
AN 2 Anthracite RAL 7016	3,96 001986	4,02 001993	4,80 002006
IC 3 Intense black RAL 9005	3,96 002013	4,02 002020	4,80 002037
OC 4 Steel red RAL 3009	3,96 002075	4,02 002082	4,80 002099
MH 5 Copper brown RAL 8004	3,96 002044	4,02 002051	4,80 002068
SB 6 Grey white RAL 9002	3,96 002105	4,02 002112	4,80 002129
Package in pcs 	25	25	25
Package in pcs 	1 000	1 000	1 000

GALV. STEEL
POLYESTER

DOWNPIPE BRACKET WITH PIN 200 mm

P-POD





Nominal dimension	80	100	120
Price in €/pcs	With VAT	With VAT	With VAT
TM 1 Testa di Moro RAL 8028	4,20 001955	4,20 001962	4,86 001979
AN 2 Anthracite RAL 7016	4,20 001801	4,20 001818	4,86 001825
IC 3 Intense black RAL 9005	4,20 001832	4,20 001849	4,86 001856
OC 4 Steel red RAL 3009	4,20 001894	4,20 001900	4,86 001917
MH 5 Copper brown RAL 8004	4,20 001863	4,20 001870	4,86 001887
SB 6 Grey white RAL 9002	4,20 001924	4,20 001931	4,86 001948
Package in pcs 	25	25	25
Package in pcs 	1 000	1 000	1 000

GALVANIZED STEEL POLYESTER

DOWNPIPE BRACKET WITH PIN 300 mm

P-PODD

Nominal dimension	100	120
Price in €/pcs	With VAT	With VAT
TM 1 Testa di Moro RAL 8028	5,46 002402	5,94 002419
AN 2 Anthracite RAL 7016	5,46 002303	5,94 002310
IC 3 Intense black RAL 9005	5,46 002327	5,94 002334
OC 4 Steel red RAL 3009	5,46 002365	5,94 002372
MH 5 Copper brown RAL 8004	5,46 002341	5,94 002358
SB 6 Grey white RAL 9002	5,46 002389	5,94 002396
Package in pcs 	20	20
Package in pcs 	800	800



GALV. STEEL
POLYESTER



GALVANIZED STEEL POLYESTER

PIPE BRACKET WITH THREAD M10

P-POB

Nominal dimension	60	80	100	120	150
Price in €/pcs	With VAT	With VAT	With VAT	With VAT	With VAT
TM 1 Testa di Moro RAL 8028	3,48 074119	3,18 074126	3,30 074133	3,96 074140	5,88 074157
AN 2 Anthracite RAL 7016	3,48 073471	3,18 073488	3,30 073495	3,96 073501	5,88 073518
IC 3 Intense black RAL 9005	3,48 073679	3,18 073686	3,30 073693	3,96 073709	5,88 073716
OC 4 Steel red RAL 3009	3,48 073914	3,18 073921	3,30 073938	3,96 073945	5,88 073952
MH 5 Copper brown RAL 8004	3,48 073723	3,18 073730	3,30 073747	3,96 073754	5,88 073761
SB 6 Grey white RAL 9002	3,48 074010	3,18 074027	3,30 074034	3,96 074041	5,88 074058
BH 7 White aluminum RAL 9006	3,48 073570	3,18 073587	3,30 073594	3,96 073600	5,88 073617
PS 8 Dusty grey RAL 7037	3,48 073969	3,18 073976	3,30 073983	3,96 073990	5,88 074003
MM 9 Metallic copper RAL extra	3,48 073778	3,18 073785	3,30 073792	3,96 073808	5,88 077158
BHT – P.20 10 Grey aluminum RAL 9007	3,48 119711	3,18 094537	3,30 094544	3,96 094551	5,88 094674
MZ 11 Moss green RAL 6005	3,48 073860	3,18 073877	3,30 073884	3,96 073891	5,88 073907
MOT 12 Gentian blue RAL 5010	3,48 073815	3,18 073822	3,30 073839	3,96 073846	5,88 073853
TZ 13 Reseda green RAL 6011	3,48 074164 *	3,18 074171	3,30 074188	3,96 074195	5,88 074201 *
Package in pcs	25	25	25	25	20
Package in pcs	3 000	3 000	3 000	3 000	2 400

* Custom production



GALVANIZED STEEL POLYESTER

PIPE BRACKET WITH THREAD M8

P-POB





Nominal dimension	60	80	100	120	150
Price in €/pcs	With VAT	With VAT	With VAT	With VAT	With VAT
TM 1 Testa di Moro RAL 8028	3,48	3,18	3,30	3,96	5,88
	074065	074072	074089	074096	074102
AN 2 Anthracite RAL 7016	3,48	3,18	3,30	3,96	5,88
	073426	073433	073440	073457	073464
IC 3 Intense black RAL 9005	3,48	3,18	3,30	3,96	5,88
	073624	073631	073648	073655	073662
BH 7 White aluminum RAL 9006	3,48	3,18	3,30	3,96	5,88
	073532	073525	073549	073556	073563
Package in pcs	25	25	25	25	20
Package in pcs	3 000	3 000	3 000	3 000	2 400



GALVANIZED STEEL POLYESTER

STAINLESS STEEL SCREW FOR DOWNPIPE BRACKET M6x20 P-POB-NSK





Nominal dimension	EAN product number	Packaging in pcs		Price with VAT [€/pcs]
				
M6 x 20 *	071675	1	–	0,18

* Custom production



SCREW FOR DOWNPIPE BRACKET WITH THREADED TORX M10 P-POB-HT



Nominal dimension	EAN product number	Packaging in pcs		Price with VAT [€/pcs]
				
80	002464	100	40 000	1,20
140	002471	100	28 000	1,50
200	002488	100	20 000	1,86
250	002495	100	16 000	2,04
300	002501	100	11 200	2,04



DOWEL M10 P-POB-HN DB



Nominal dimension	EAN product number	Packaging in pcs		Price with VAT [€/pcs]
				
120	002426	100	25 000	0,48



DOWEL WITH LAMELLA M10 P-POB-HN DB



Nominal dimension	EAN product number	Packaging in pcs		Price with VAT [€/pcs]
				
180	002433	100	12 000	0,50
240	002440	100	12 000	0,60
280	002457	100	12 000	0,64

COMBISCREW TORX M10 P-POB-ZT/SZ



Nominal dimension	EAN product number	Packaging in pcs		Price with VAT [€/pcs]
				
140	002587	50	10 400	0,54
180	002594	50	10 400	0,66

GALVANIZED STEEL POLYESTER

DOWEL FOR DOWNPIPE BRACKET SQUARE PIM 7x7

P-POB-HN R1



Nominal dimension	EAN product number	Packaging in pcs		Price with VAT [€/pcs]
200/60	002600	250	15 000	0,22

INSULATION DOWEL M10

P-POB-HN IZOL



Nominal dimension	EAN product number	Packaging in pcs		Price with VAT [€/pcs]
M10 x 96	001207	25	2 625	3,24

INSULATING DOWEL TIP OF THE BRICK WITHOUT INSULATION

P-POB-HN WDVS140 M10



Nominal dimension	EAN product number	Packaging in pcs		Price with VAT [€/pcs]
140	144843	1/5	750	5,76

INSULATING DOWEL TIP OF THE BRICK WITH INSULATION

P-POB-HN WDVS300 M10



Nominal dimension	EAN product number	Packaging in pcs		Price with VAT [€/pcs]
300	144850	1/5	500	9,36

STAINLESS STEEL UNI PLATFORM TO ATTACH OB M10

P-POB-HN PLAT M10



Nominal dimension	EAN product number	Packaging in pcs		Price with VAT [€/pcs]
M10	144836	25/500	5 000	4,02

THREADED ROD M10

P-POB-ZT





Nominal dimension	EAN product number	Packaging in pcs		Price with VAT [€/pcs]
60	002556	100	20 800	0,24
100	002563	100	15 600	0,36
150	002570	50	10 400	0,66

GALVANIZED STEEL POLYESTER

DOWNPIPE BRACKET MOUNTING PLATE M10

P-POB-ZT MP





Nominal dimension	EAN product number	Packaging in pcs		Price with VAT [€/pcs]
				
80 x 30	002518	25	5 200	1,38

SCREW FOR DOWNPIPE BRACKET WITH THREADED M8

P-POB-HB





Nominal dimension	EAN product number	Packaging in pcs		Price with VAT [€/pcs]
				
150	071590	100	5 000	0,78
200	071606	100	5 000	1,10
250	071613	100	5 000	1,26
300	071620	100	5 000	1,32

DOWEL M8

P-POB-HBN-SS













Nominal dimension	EAN product number	Packaging in pcs		Price with VAT [€/pcs]
				
150	071637	100	5 000	0,24
200	071644	100	5 000	0,30
250	071651	100	5 000	0,30
300	071668	100	8 000	0,44

RUBBER CAP FOR DOWNPIPE BRACKET SCREW

P-POB-HT AKG



Nominal dimension	EAN product number	Packaging in pcs		Price with VAT [€/pcs]
				
 29 x 13	002280	50	16 800	0,30
 29 x 13	002211	50	16 800	0,30
 29 x 13	002235	50	16 800	0,30
 29 x 13	002266	50	16 800	0,30
 29 x 13	002242	50	16 800	0,30
 29 x 13	002228	50	16 800	0,30
 29 x 13	002273	50	16 800	0,30
 29 x 13	002259	50	16 800	0,30
 29 x 13	002297	50	16 800	0,30

GALVANIZED STEEL POLYESTER

DOWNPIPE FLAP

P-PZV



Nominal dimension	80	100	120
Price in €/pcs	With VAT	With VAT	With VAT
TM 1 Testa di Moro RAL 8028	15,06 034533	15,54 034540	22,80 034557
AN 2 Anthracite RAL 7016	15,06 034410	15,54 034427	22,80 034434
IC 3 Intense black RAL 9005	15,06 034441	15,54 034458	22,80 034465
OC 4 Steel red RAL 3009	15,06 034502	15,54 034519	22,80 034526
MH 5 Copper brown RAL 8004	15,06 034472	15,54 034489	22,80 034496
Package in pcs	6	5	3
Package in pcs	180	150	90

GALV. STEEL
POLYESTER

DOWNPIPE FLAP WITH SIEVE

P-PZVS



Nominal dimension	80	100	120
Price in €/pcs	With VAT	With VAT	With VAT
TM 1 Testa di Moro RAL 8028	15,06	15,54	22,80
	034861	034878	034885
AN 2 Anthracite RAL 7016	15,06	15,54	22,80
	034564	034571	034588
IC 3 Intense black RAL 9005	15,06	15,54	22,80
	034625	034632	034649
OC 4 Steel red RAL 3009	15,06	15,54	22,80
	034779	034786	034793
MH 5 Copper brown RAL 8004	15,06	15,54	22,80
	034656	034663	034670
SB 6 Grey white RAL 9002	15,06	15,54	22,80
	034830	034847	034854
BH 7 White aluminum RAL 9006	15,06	15,54	22,80
	034595	034601	034618
PS 8 Dusty grey RAL 7037	15,06	15,54	22,80
	034809	034816	034823
MM 9 Metallic copper RAL extra	15,06	15,54	22,80
	034687	034694	034700
BHT – P.20 10 Grey aluminum RAL 9007	15,06	15,54	22,80
	095718	095725	095732
MZ 11 Moss green RAL 6005	15,06	15,54	22,80
	034748	034755	034762
MOT 12 Gentian blue RAL 5010	15,06	15,54	22,80
	034717	034724	034731
TZ 13 Reseda green RAL 6011	15,06	15,54	22,80
	034892 *	034908	034915
Package in pcs	6	5	3
Package in pcs	180	150	90

* Custom production

ALUMINIUM WATER COLLECTOR+HOSE

P-PZVHA



Dimension: 80, 120



Dimension: 100

GALV. STEEL
POLYESTER

Nominal dimension	80	100	120
Price in €/pcs	With VAT	With VAT	With VAT
TM 1 Testa di Moro RAL 8028	78,00 018793	72,00 018809	150,00 018816
AN 2 Anthracite RAL 7016	78,00 018496	72,00 018502	150,00 018519
IC 3 Intense black RAL 9005	78,00 018557	72,00 018564	150,00 018571
OC 4 Steel red RAL 3009	78,00 018700	72,00 018717	150,00 018724 *
MH 5 Copper brown RAL 8004	78,00 018588 *	72,00 018595	150,00 018601 *
SB 6 Grey white RAL 9002	78,00 018762 *	72,00 018779	150,00 018786
BH 7 White aluminum RAL 9006	78,00 018526	72,00 018533	150,00 018540
PS 8 Dusty grey RAL 7037	78,00 018731 *	72,00 018748	150,00 018755 *
MM 9 Metallic copper RAL extra	78,00 018618 *	72,00 018625 *	150,00 018632 *
BHT – P.20 10 Grey aluminum RAL 9007	78,00 095527 *	72,00 095534 *	150,00 095541 *
MZ 11 Moss green RAL 6005	78,00 018670 *	72,00 018687	150,00 018694 *
MOT 12 Gentian blue RAL 5010	78,00 018649 *	72,00 018656 *	150,00 018663 *
TZ 13 Reseda green RAL 6011	78,00 018823 *	72,00 018830 *	150,00 018847 *
Package in pcs	1	1	1
Package in pcs	60	60	60

* Custom production

GALVANIZED STEEL POLYESTER

PROTEC.GUTTER PIPE COL.

P-POZR





Nominal dimension	80	100	100
Length in m	1,0	1,0	1,5
Price in €/m	With VAT	With VAT	With VAT
TM 1 Testa di Moro RAL 8028	76,80	58,80	116,40
	010254 *	010261	010278
AN 2 Anthracite RAL 7016	76,80	58,80	116,40
	009760 *	009777	009784 *
IC 3 Intense black RAL 9005	76,80	58,80	116,40
	009869 *	009876	009883 *
OC 4 Steel red RAL 3009	76,80	58,80	116,40
	010117 *	010124 *	010131 *
MH 5 Copper brown RAL 8004	76,80	58,80	116,40
	009913 *	009920 *	009937 *
SB 6 Grey white RAL 9002	76,80	58,80	116,40
	010209 *	010247 *	010216 *
BH 7 White aluminum RAL 9006	76,80	58,80	116,40
	009814 *	009821 *	009838 *
PS 8 Dusty grey RAL 7037	76,80	58,80	116,40
	010162 *	010179 *	010186 *
MM 9 Metallic copper RAL extra	76,80	58,80	116,40
	009968 *	009975 *	009982 *
BHT – P.20 10 Grey aluminum RAL 9007	76,80	58,80	
	096494 *	096500 *	
MZ 11 Moss green RAL 6005	76,80	58,80	116,40
	010063 *	010070 *	010087 *
MOT 12 Gentian blue RAL 5010	76,80	58,80	116,40
	010018 *	010025 *	010032 *
TZ 13 Reseda green RAL 6011	76,80	58,80	116,40
	010308 *	010315 *	010322 *
Package in pcs	1	1	1
Package in pcs	70	60	60

* Custom production

GALVANIZED STEEL POLYESTER

PROTEC.GUTTER PIPE COL.



P-POZR

Nominal dimension	120	120
Length in m	1,0	1,5
Price in €/m	With VAT	With VAT
TM Testa di Moro RAL 8028	138,00	198,00
	010285	010292 *
AN Anthracite RAL 7016	138,00	198,00
	009791 *	009807 *
IC Intense black RAL 9005	138,00	198,00
	009890 *	009906 *
OC Steel red RAL 3009	138,00	198,00
	010148 *	010155 *
MH Copper brown RAL 8004	138,00	198,00
	009944 *	009951 *
SB Grey white RAL 9002	138,00	198,00
	010223 *	010230 *
BH White aluminum RAL 9006	138,00	198,00
	009845 *	009852 *
PS Dusty grey RAL 7037	138,00	198,00
	010193 *	009753 *
MM Metallic copper RAL extra	138,00	198,00
	009999 *	010001 *
BHT – P.20 Grey aluminum RAL 9007	138,00	198,00
	096517 *	
MZ Moss green RAL 6005	138,00	198,00
	010094 *	010100 *
MOT Gentian blue RAL 5010	138,00	198,00
	010049 *	010056 *
TZ Reseda green RAL 6011	138,00	198,00
	010339 *	010346 *
Package in pcs 	1	1
Package in pcs 	40	40

* Custom production

PIPE CLAMP WITH GASKET M10

P-POB-OZR

Nominal dimension	EAN product number	Packaging in pcs		Price with VAT [€/pcs]
				
80	002525	25	1 250	1,86
100	002532	25	1 250	2,40
120	002549	20	1 000	2,70



GALV. STEEL
POLYESTER



GALVANIZED STEEL POLYESTER

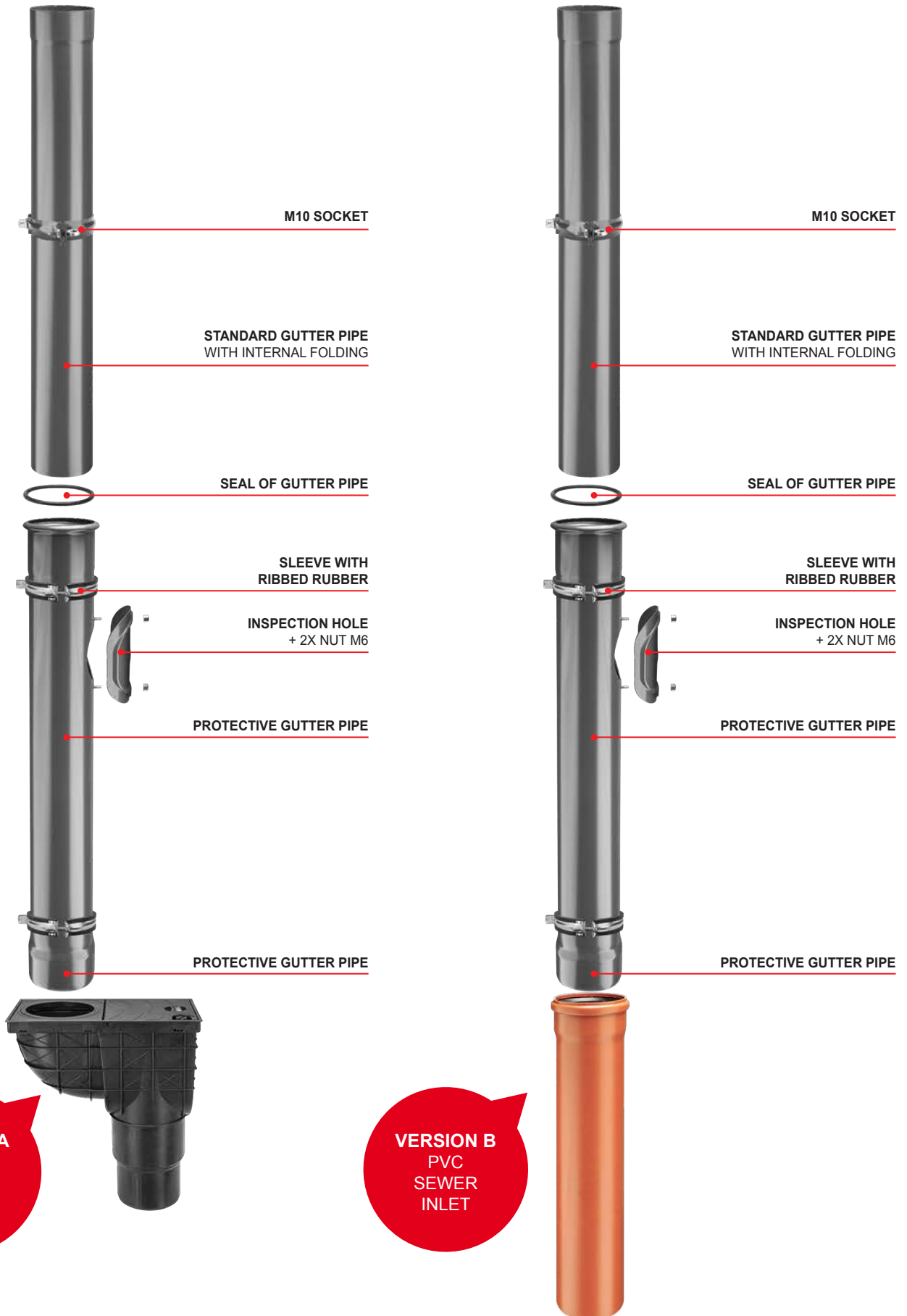

GALV. STEEL
POLYESTER

I. BASIC PROVISIONS

- The company KJG a.s., with its registered office at Malinovského 800/131, 916 21 Čachtice, Company ID: 31 439 951 (hereinafter referred to as the „Seller“), issues the following General business terms and conditions that apply to the sale and supply of gutter roof system with accessories, light roofing, trapezoids, metallurgical materials, roofing accessories, tools, machinery and commercial goods related to the roof system (hereinafter referred to as the „goods“) performed by the Seller on the basis of a framework purchase contract (referred to as „FPC“) in relation to an entrepreneur in carrying out its business activities and to the state, state organization, self-governing territorial unit or to a legal entity established by law as a public institution in the provision of public needs or its own operation (hereinafter referred to as the „Buyer“).
- These General terms and conditions as an integrated part of FPC are an integral part of each individual purchase contract (hereinafter also „IPC“ or „contract“) concluded between the Seller and the Buyer on the basis of FPC.

II. CONCLUSION OF PURCHASE CONTRACT

- The Buyer's written order is considered to be a proposal to conclude an IPC, whereby each Buyer's order should contain:
 - identification data of the Buyer necessary for issuing the invoice,
 - specification of the ordered goods (especially type, kind, quantity and dimensions),
 - delivery place, delivery time and method of delivery of goods,
 - date of issue of the order,
 - name, surname, position and signature of the person authorized to act on behalf of the Buyer.
- The IPC is considered closed at the moment of written confirmation of the Buyer's order by the Seller.

III. PURCHASE PRICE AND PAYMENT TERMS

- The Buyer undertakes to pay the Seller the purchase price for the ordered goods properly and in due time. The purchase price is determined according to the Seller's price list (prices of goods are to be understood without VAT) valid on the day of submitting the order by the Buyer and its amount will be stated by the Seller in the Buyer's order confirmation including VAT (when delivering goods in Slovakia) according to valid legal regulations. In necessary cases, if the purchase price is determined on the basis of individual price calculation based on the valid price list, the Buyer shall be obliged to pay the purchase price up to the amount determined by price calculation on condition that the Seller shall determine the final purchase price according to costs incurred, but this shall not exceed the purchase price determined by calculation. The buyer is entitled to a discount on the price of the goods in the amount resulting from the FPC; if the Seller changes the amount of the Buyer's discount on the price of the goods during the FPC period, it shall immediately inform the Buyer in writing. When delivering the goods in the Slovak Republic, the Seller charges the Buyer, in addition to the price of the goods, VAT in accordance with the valid legal regulations.
- The Buyer shall have a set financial credit limit for the purchase of goods and the maturity of invoices in accordance with the FPC, while the Seller shall be entitled to invoice the purchase price to the Buyer on the day of delivery or shipping the goods to the Buyer, respectively. After overdrawing the credit limit specified in the FPC or in the case of non-payment of the invoice by the Buyer within the due date, the Seller is entitled to interrupt the delivery of goods to the Buyer on the basis of the contract and not to confirm another written order of the Buyer. The Seller shall continue with further deliveries of goods:
 - in the case of exceeded credit limit - after payment of the oldest invoices up to the amount of exceeding the credit limit and simultaneous payment of the value of the required purchase of goods,
 - in the case of non-payment of the invoice within the due date - after its full payment. The Seller shall be entitled to change the credit limit set for the Buyer at any time throughout the duration of the FPC.
- Payment shall be deemed to have been made in time if it has been credited to the Seller's account or paid in cash at the Seller's cash desk by the due date.
- If the Buyer does not pay the invoice within the due date, the Seller shall be entitled to charge the Buyer for interest on late payment in the amount of 0.05 % of the unpaid amount for each day of delay.

IV. DELIVERY OF GOODS AND RETENTION OF TITLE

- The Seller shall be obliged to deliver the goods to the Buyer in the quantity agreed in the contract and in a quality and design that is suitable for the purpose for which the goods are used. The Buyer is obliged to take over the goods delivered by the Seller.
- Unless the contracting parties have agreed otherwise, the Seller is obliged to pack or arrange the goods for transport in the manner that is usual for such goods in business.
- Delivery of the goods shall take place within the period and in the manner agreed by the contracting parties in the contract.
- Upon delivery of the goods by the Seller, the Buyer's employee shall be obliged to prove the right to take over the goods.
- If the goods are to be made available not loaded on a means of transport at the Seller's registered office (or the relevant warehouse of the Seller, to which the Buyer has submitted an order) by the Buyer to the designated carrier, the latter is obliged to prove the right to take over the goods.
- In the event that the goods are to be delivered to the Buyer to the delivery point specified in the order using a Seller's vehicle, the Seller will charge the Buyer for transport costs according to the transport price list valid on the day of submitting the order by the Buyer. At the same time, the Seller reserves the right to unload the goods only in an available terrain at its sole discretion.
- In the case of goods to be sent to the Buyer, the Seller shall charge the Buyer for postage, unless agreed otherwise.
- The Buyer undertakes to withdraw the goods within the delivery period. If the Buyer fails to fulfil its obligation to take over the goods within the delivery period, the Seller shall invite the Buyer to fulfil the Seller's obligation within an additional reasonable period. Failure to take over the goods by the Buyer nor within an additional reasonable period gives rise to the Seller's right to withdraw from the contract.
- The buyer who does not pay the whole amount of the purchase price until the delivery of the goods will acquire ownership of the delivered goods only after full payment of the purchase price.

V. PASSING OF RISK OF DAMAGE TO GOODS

- The risk of damage to the goods passes to the Buyer at the moment the Buyer takes over the goods from the Seller, or by the carrier designated by him, or if the Buyer fails to do so in time, at the time when the Seller or the Seller's designated carrier allows the Buyer to dispose of the goods, while the Buyer is being aware of this possibility and breaches the contract by not taking over the goods.
- If the Seller is to hand over the goods for transport by the carrier designated by the Buyer at its registered office in Čachtice (or the relevant warehouse of the Seller) from which the Buyer is to take over the goods, the risk of damage to the goods passes to the Buyer upon handing over the goods to this carrier.
- In the event that the Seller is to send the goods to the Buyer, the risk of damage to the goods passes to the Buyer at the time of delivery of the goods to the first carrier for transport to the destination.
- The buyer is obliged to inspect the goods without undue delay after the risk of damage to the goods has passed. If the goods are sent to the Buyer, the Buyer is obliged to inspect the goods without undue delay after their delivery to the destination. The company KJG a.s. reserves the right to change prices, packaging and printing.

VI. LIABILITY FOR DEFECTS AND WARRANTY

- The Seller shall be responsible for the defect by which the goods have been affected at the moment when the risk of damage to the goods passes to the Buyer, even if the defect becomes apparent only after this time. The Seller is also responsible for any defect arising after the risk of damage to the goods has passed to the Buyer if caused by a breach of the Buyer's duties.
- If the Buyer does not inspect the goods or does not arrange to inspect them at the time of passing the risk of damage to the goods, the Buyer may claim for defects detectable during this inspection only if the Buyer proves that the goods were already affected by these defects at the time of passing the risk of damage to the goods.
- The Buyer shall be obliged to notify the Seller of defects in the goods without undue delay after:
 - The Buyer found the defects,
 - The Buyer, while exercising professional care, should have found defects during the inspection, which the Buyer is obliged to carry out after the risk of damage to the goods has passed, or
 - The defects could be found later with the exercise of professional care, but no later than within two years from the time of delivery of the goods, or from the arrival of the goods to the destination specified in the contract. For defects covered by the quality warranty, instead of this period of time the warranty period applies.
- If the Seller provides the Buyer with a warranty for the quality of the delivered goods, it shall do so by making a statement in a separate warranty card, which will also state the procedure for complaints.
- The warranty period begins to run from the date of delivery of the goods. If the Seller is obliged to send the goods, the warranty period runs from the day the goods arrive at its destination. The warranty period does not run for a period during which the Buyer cannot use the goods due to their defects, which is the Seller's responsibility.
- In the case of delivery of goods to the Buyer with defects, the use of prov. § 436, § 437, § 439 par. 2, 3, 4 and § 441 of the Commercial Code are explicitly excluded and the Seller in such a case shall provide the Buyer with a discount on the purchase price or shall remove the defects in the goods complained by the Buyer:
 - by delivery of missing goods,
 - by repair of goods or delivery of replacement goods in case of remediable defects
 - by delivery of replacement goods in the event of irreparable defects.
- The discount granted by the Seller on the purchase price shall correspond to the difference between the value of the goods without defects and the value of the goods delivered with defects, while the decisive time for determining the values is the time at which proper fulfillment should have taken place. The Buyer, to whom the Seller has been granted a discount on the purchase price, is not entitled to claim compensation for the loss of profit due to the lack of properties of the goods to which the discount applies.
- Upon delivery of replacement goods, the Seller shall be entitled to demand the exchanged goods to be returned to the Seller at the Buyer's expense in the condition in which they were delivered to the Buyer. This does not apply if the impossibility of returning the goods in the condition specified therein is not caused by the actions or omissions of the Buyer, or if the change in the condition of the goods occurred as a result of an inspection duly performed to detect defects in the goods. In the event that before the detection of defects the Buyer sold the goods or part thereof or consumed the goods in whole or in part or altered them in their normal use, the Buyer shall be obliged to return unsold or unconsumed goods or altered goods and provide the Seller with compensation to the extent to which the Seller has benefited from that use of the goods.
- The Seller's responsibility for defects not covered by the quality warranty does not arise if these defects were caused after the passing of the risk of damage to the goods by external events and were not caused by the Seller or the persons who helped to fulfil the Seller's obligation.

VII. VIS MAJOR

- If, after the conclusion of the contract, unforeseeable and uncontrollable circumstances arise which create a permanent or temporary obstacle to the fulfillment of the obligations of the contracting parties of the concluded contract (refer to vis major), the non-fulfillment of obligations (in case of permanent obstacle) by a contracting party, or a delayed fulfillment of obligations (in case of temporary obstacle), shall not be considered a breach of this contract and the contracting party shall not be responsible for any damages that arise in connection with non-fulfillment of contractual obligations. If the obstacle incurred is only temporary for the fulfillment of obligations under the contract, the contracting parties undertake to start fulfilling their contractual obligations immediately after this obstacle disappears. Each contracting party shall be obliged to inform immediately the other contracting party of the occurrence of the above obstacles.
- The followings are mainly considered to be vis major: natural events, arbitrary acts of third parties, strikes, work lockouts, blockades, wars (declared or undeclared), a change in the political situation or any other similar event which precludes or unduly impedes the exercise of rights and obligations under the contract.

VIII. PRIVACY POLICY

- The Buyer (for the purposes of this article also another person signed on the FPC and the order on behalf of the Buyer) expressly grants to the Seller, according to Act no. 428/2002 Coll. on personal data protection as amended (hereinafter referred to as the „Act“), consent to the processing of its personal data specified in the FPC and the Buyer's order.
- The Buyer expressly authorizes the Seller to process personal data for the purposes of:
 - exercise of the rights and obligations arising from the FPC and IPC,
 - keeping records, the obligation of which arises for the Seller by law or on the basis of the Act,
 - performing marketing activities.
- The Buyer expressly gives the Seller consent to provide the Buyer's personal data for the purposes stated in point 8.2 to a third party which has been entrusted by the Buyer with the activity in question.
- The Buyer expressly grants the Seller consent to the processing of personal data:
 - for the period in which the Seller is obliged to keep the records referred to in point 8.2. b /,
 - for the period in which it is necessary to protect the legal rights and legally protected interests of the Seller.
- The Buyer takes into account that it has the right to revoke its consent to the processing of personal data and require the liquidation of its personal data in the event that the Seller, or a third party to whom the Seller has provided personal data, respectively, breaches the obligations arising from the Act.

IX. FINAL PROVISIONS

- The Buyer is not entitled to transfer or assign the rights resulting for the Buyer from the FPC or IPC to a third party without the express consent of the Seller.
- The FPC may be amended, unless otherwise provided in these General Terms and Conditions, only in the form of written amendments signed by representatives of both the contracting parties.
- The agreed deviating provisions in the IPC between the Seller and the Buyer take precedence over the provisions of the FPC and these General Terms and Conditions. Legal relations that are not regulated in the FPC, IPC or in these General Terms and Conditions are governed by the Commercial Code and other generally binding legal regulations in force in the Slovak Republic, excluding the use of conflicting rules of law and the application of the UN Convention on Contracts for the International Sale of Goods /CISG/ of April 11, 1980 and their possible amendments in the case the Buyer has its registered office (place of business) in another state or the goods are delivered to another state.
- All disputes arising from the implementation of the content of the FPC will be resolved by the contracting parties through an amicable settlement. Disputes that cannot be resolved by mutual agreement are entitled to be resolved (exclusively) by the competent court in the Slovak Republic.
- These General Terms and Conditions are issued by the Seller pursuant to § 273 of the Commercial Code, with effect from January 1, 2017.