



GUTTER SYSTEM SEMI CIRCULAR – CIRCULAR



PRICE LIST
2024

RECOMMENDED CONSUMER PRICES



POWERFUL PARTNER FOR YOUR ROOF



Galvanized steel material | 3



Gutter | 6

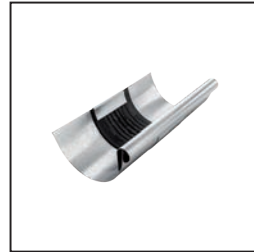

Gutter expanders | 8



Gutter accessories | 10



Gutter hook | 11



Corner | 14



End Cap | 14



Outlet | 15



Elbow | 19

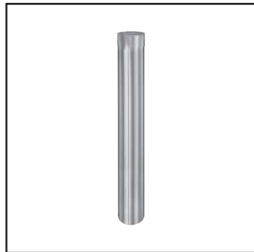

Downpipe | 21



Downpipe accessories | 23



Pipe bracket | 24



Pipe bracket accessories | 25



Downpipe flap | 29



Protective gutter pipe | 30

GUTTER SYSTEM SEMI CIRCULAR – CIRCULAR

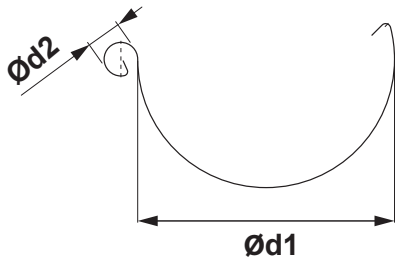

ROOF GUTTER DIMENSIONS

(dimensions and dimensional tolerances according to EN 612)

Developed width (mm)	200	250	280	333	400	500
$\varnothing d1$	80	105	127	153	192	250
$\varnothing d2$	16	18	18	20	22	22

INNER FOLD

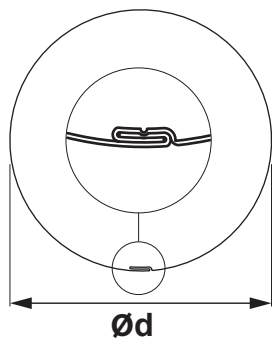

SPOUT PIPE DIMENSIONS

(dimensions and dimensional tolerances according to EN 612)

Dimensions	60	80	100	120	150
Nominal size $\varnothing d$ (mm)	60	80	100	120	150

GUTTER BRACKET DIMENSIONS

(dimensions and dimensional tolerances according to EN 612)

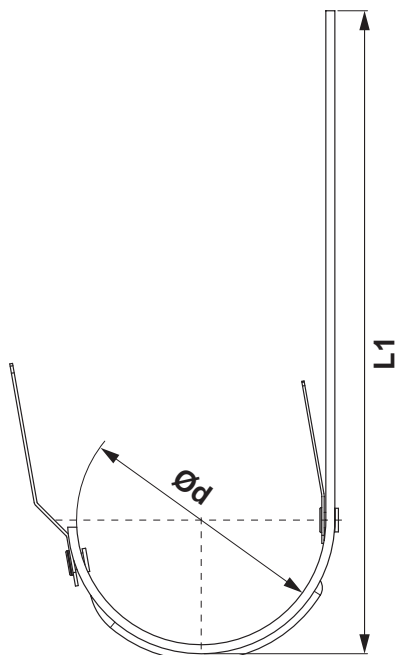

Dimensions (mm)	L1	$\varnothing d$
200	290	80
250	310	105
280	345	127
333 – 510	345	153
333 – 550	385	153
333 – 610	445	153
400	400	192

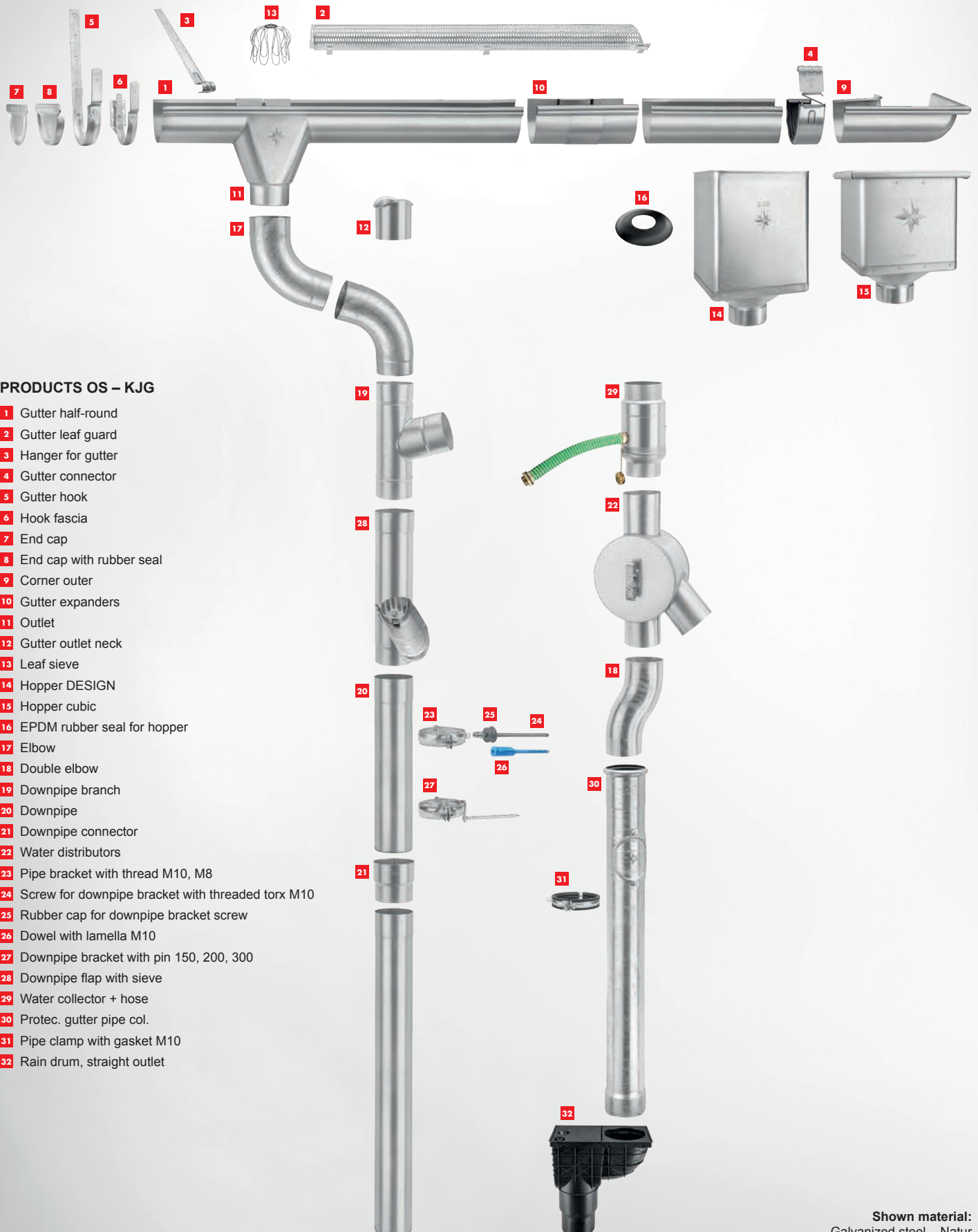

PRODUCTS OS – KJG

- 1** Gutter half-round
- 2** Gutter leaf guard
- 3** Hanger for gutter
- 4** Gutter connector
- 5** Gutter hook
- 6** Hook fascia
- 7** End cap
- 8** End cap with rubber seal
- 9** Corner outer
- 10** Gutter expanders
- 11** Outlet
- 12** Gutter outlet neck
- 13** Leaf sieve
- 14** Hopper DESIGN
- 15** Hopper cubic
- 16** EPDM rubber seal for hopper
- 17** Elbow
- 18** Double elbow
- 19** Downpipe branch
- 20** Downpipe
- 21** Downpipe connector
- 22** Water distributors
- 23** Pipe bracket with thread M10, M8
- 24** Screw for downpipe bracket with threaded torx M10
- 25** Rubber cap for downpipe bracket screw
- 26** Dowel with lamella M10
- 27** Downpipe bracket with pin 150, 200, 300
- 28** Downpipe flap with sieve
- 29** Water collector + hose
- 30** Protec. gutter pipe col.
- 31** Pipe clamp with gasket M10
- 32** Rain drum, straight outlet

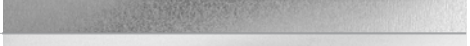
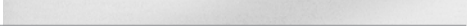
Material name	RAL	Glossy/ Matt	s = (mm)								ILLUSTRATED STRUCTURE
			0,45	0,50	0,55	0,60	0,70	0,75	0,80	1,00	
● GALVANIZED MATERIAL USS	Natural	Matt	✓	✓	✓	✗	✗	✗	✓	✗	
● GALVANIZED MATERIAL DUN	Natural	Glossy	✓	✓	✓	✓	✓	✓	✗	✓	
● GALVANIZED MATERIAL VOEST	Natural	Glossy	✗	✗	✗	✓	✗	✗	✓	✗	

* The illustrated structure may be different from the actual structure depending on the setting of the monitor or print quality.

U. S. Steel

U. S. Steel Košice, s.r.o. is the largest steel producer in Slovakia with more than 50 years of tradition and also one of the largest companies in Slovakia. The product mix includes products with high added value, which find application in the automotive, packaging, electrical, consumer and construction industries.



DUNAFERR

ISD DUNAFERR Company Group seated in Dunaújváros is one of the largest industrial producers in Hungary. The activity of the company group having a history of over seven decades is focused on customer-oriented production. Hot rolled, pickled, cold rolled, galvanized strips and sheets, as well as open and hollow steel sections produced by ISD DUNAFERR are used primarily for the manufacturing of engineering, automotive and construction industrial products.

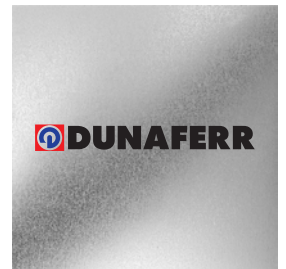

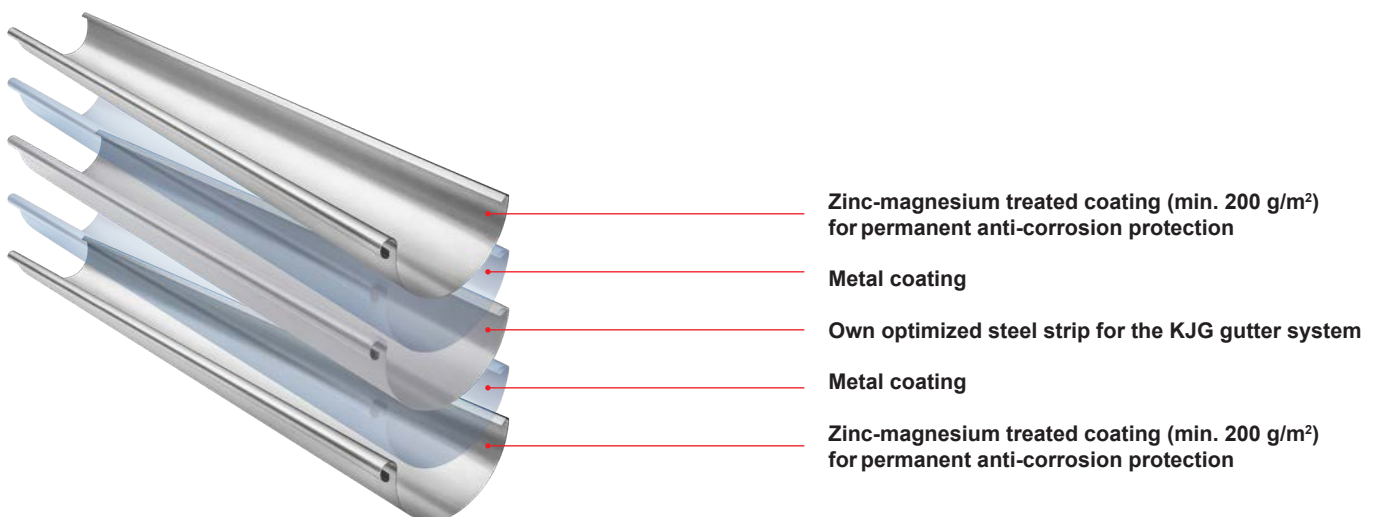

VOESTALPINE

Voestalpine is seated in Linz, Austria and is one of European leading partners in the automotive, consumer and energy industries. In addition, it is a world market leader in railway technology, tooling and special steels. Voestalpine steel can also be found in numerous products, such as the latest generation of Airbus, buildings such as the Atomium in Brussels, Wembley Stadium in London and the Burj Dubai, the tallest building in the world. Voestalpine is represented by 500 Group companies, which consists of four divisions. The High Performance Metals division, being one of the divisions and it focuses on technologically demanding products in the field of special steels.



GUTTER HALF-ROUND [s=0,55]

P-PZ

Nominal dimension	Lenght in m	EAN product number	Packaging in m		Price with VAT [€/m]
					
200	2,0	003393	10	800	4,26
200	3,0	003409	15	1 200	4,26
200	4,0	003416	20	1 600	4,26
250	2,0	003430	10	480	4,26
250	3,0	003454	15	720	3,84
250	4,0	003478	20	960	3,84
250	5,0	003492	25	1 200	3,84
250	6,0	003515	30	1 440	3,84
280	2,0	003539	10	420	4,68
280	3,0	003553	15	630	4,26
280	4,0	003577	20	840	4,26
280	5,0	003591	25	1 050	4,26
280	6,0	003614	30	1 260	4,26
333	2,0	003638	10	330	4,80
333	3,0	003652	15	495	4,68
333	4,0	003676	20	660	4,68
333	5,0	003690	25	825	4,68
333	6,0	003713	30	990	4,68
400	3,0	003720	15	405	8,52
400	4,0	003737	20	540	8,52
400	5,0	003744	25	675	8,52
400	6,0	003751	30	810	8,52
500 *	4,0	003768	20	200	14,28

* Custom production





GALVANIZED STEEL

GUTTER HALF-ROUND [s=0,50]

P-PZ





Nominal dimension	Lenght in m	EAN product number	Packaging in m		Price with VAT [€/m]
					
250 *	2,0	003423	10	480	3,24
250 *	3,0	003447	15	720	3,18
250 *	4,0	003461	20	960	3,18
250 *	5,0	003485	25	1 200	3,18
250 *	6,0	003508	30	1 440	3,18
280 *	2,0	003522	10	420	3,72
280 *	3,0	003546	15	630	3,60
280 *	4,0	003560	20	840	3,60
280 *	5,0	003584	25	1 050	3,60
280 *	6,0	003607	30	1 260	3,60
333 *	2,0	003621	10	330	4,20
333 *	3,0	003645	15	495	4,08
333 *	4,0	003669	20	660	4,08
333 *	5,0	003683	25	825	4,08
333 *	6,0	003706	30	990	4,08

* Custom production

GUTTER HALF-ROUND [s=0,45]

P-PZ



Nominal dimension	Lenght in m	EAN product number	Packaging in m		Price with VAT [€/m]
					
250 *	3,0	097903	15	720	3,00
250 *	4,0	097910	20	960	3,00
280 *	3,0	097927	15	630	3,24
280 *	4,0	097934	20	840	3,24
333 *	3,0	097941	15	495	3,78
333 *	4,0	097958	20	660	3,78

* Custom production

GALVANIZED STEEL NATUR

GUTTER ON-ROOF [s=0,55]

P-PZS



Nominal dimension	Lenght in m	EAN product number	Packaging in m		Price with VAT [€/m]
500	4,0	049711	4	200	9,60
650 *	3,0	094360	3	150	11,40
650	4,0	049728	4	200	11,40
650	6,0	049735	6	300	11,40
800 *	4,0	049742	4	160	13,20

* Custom production

GUTTER EXPANDERS

P-PZDI



Nominal dimension	EAN product number	Packaging in pcs		Price with VAT [€/pcs]
250/260	012623	3	360	13,08
280/260	012630	3	360	13,20
333/260	012647	5	200	13,68
400/260	012654	5	200	18,00



ON-ROOF GUTTER EXPANSION COMPONENT

P-PZSDI

Nominal dimension	EAN product number	Packaging in pcs		Price with VAT [€/pcs]
670/260	013538	1	40	30,96

ENDLESS TAPES

P-PZDIP

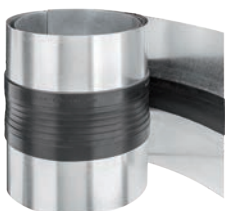

Nominal dimension	Lenght in m	EAN product number	Packaging in m		Price with VAT [€/m]
260	3,0	012470	3	120	40,32
260	6,0	012487	6	240	40,32

USE OF DILATATION GUTTER AND DILATATION STRIP

DILATATION GUTTER

Installation example: hanging gutter with a developed width of up to 500 mm. The dilatation gutter shall be installed at spacing of 15 m. For outer corner and beginning of the gutter, a half of the standard value is applied: maximum 7,5 m. For inner corner, a quarter of the standard value is applied: maximum 3,75 m. For other materials and dimensions: see the table below. Corners are always taken into account as fixed points.

ROOF SEMICIRCULAR DILATATION GUTTERS

Developed gutter width	Aluminium	Steel, Titanium-zinc, Copper, Stainless steel
< 500	12	15
> 500	8	10

DILATATION STRIP

Indoor installation: on gutters attached without gluing to a substrate, roofs with non-standard profile and roof cladding

ROOF DILATATION STRIP

Developed gutter width	Aluminium	Steel, Titanium-zinc, Copper, Stainless steel
< 500	8	10
> 500	6	8

For outer corner or the beginning of the gutter, a half of the standard value shall be applied.

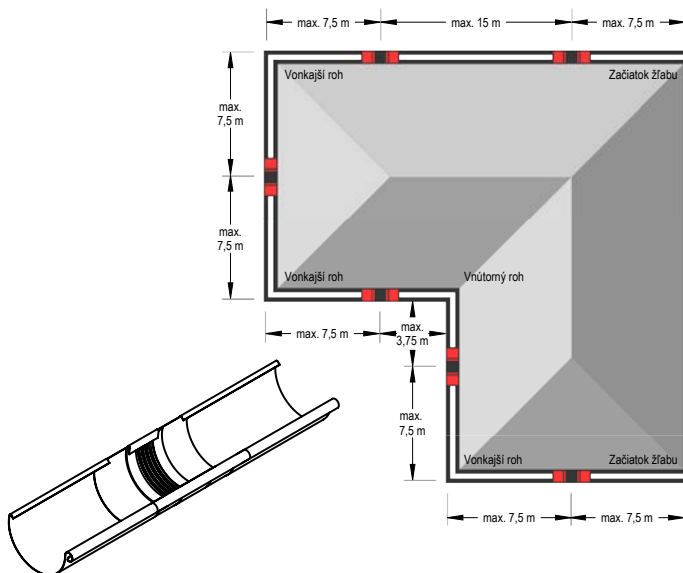

Note to the dilatation gutter mounting.

When mounting by soldering, first cover the middle rubber part with a wet cloth (to prevent heat transfer to the middle rubber part). A minimum distance of 6 cm from the middle rubber part must be kept. In any case avoid contact of rubber with open flame.

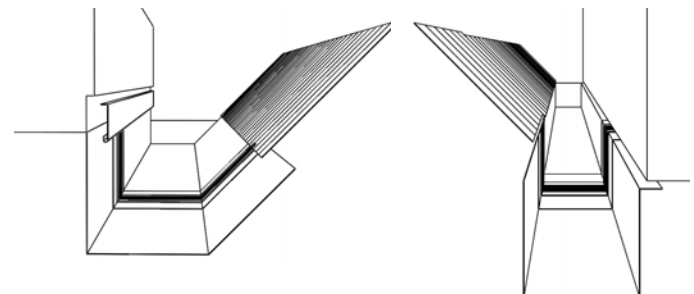

Note to the dilatation strip mounting.

When bending and mounting dilatation elements, make sure that:

- Bending jaws have a radius of at least 2 mm.
- For sheet metal thicknesses over 1 mm, it must be observed bending radius at least 5 mm.
- When bending, the bending jaws should be set to a thickness of the middle rubber part of 3 to 4 mm to prevent the cutting effect - damage to the rubber.
- The rubber middle part must not be compressed or damaged during bending. Therefore, an aluminium sheet strip 2 to 5 mm (thick) should be used, bent so that it can be attached as a protection to the bending jaws. This achieves a larger bending radius and prevents the rubber middle part from breaking.

GALVANIZED STEEL NATUR



ALUMINIUM GUTTER LEAF GUARD

W-WZNLN

Nominal dimension	Dĺžka v m	EAN product number	Packaging in pcs		Price with VAT [€/pcs]
333	2,0	064905	25	300	30,60

GALVANIZED STEEL

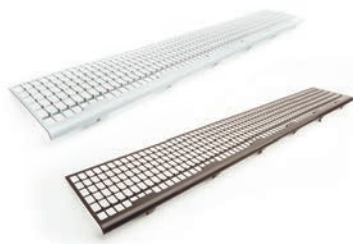

PVC GUTTER GUARD

SD-ZNL MRIEZKA

Nominal dimension	Lenght in m	EAN product number	Packaging in pcs		Price with VAT [€/pcs]
171	1,0	008473	30	450	5,40
171	1,0	008466	30	450	5,40

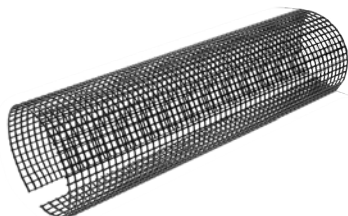

PVC GUTTER GUARD

SD-ZNL N

Nominal dimension	Lenght in m	EAN product number	Packaging in pcs		Price with VAT [€/pcs]
250	3,0	008480	10	400	28,68
280-333	3,0	008497	10	400	28,80





GALVANIZED STEEL

NATUR

HANGER FOR GUTTER

P-PDZNV





Nominal dimension	EAN product number	Packaging in pcs		Price with VAT [€/pcs]
				
18/250, 280	085269	25	3 000	1,14
20/333	085276	25	3 000	1,14
22/400 *	085283	25	3 000	1,14

* Custom production

GUTTER CONNECTOR

P-PSPZ





Nominal dimension	EAN product number	Packaging in pcs		Price with VAT [€/pcs]
				
250	083418	5	600	3,24
280	083425	5	600	3,24
333	083432	5	600	3,36

GALVANIZED STEEL

GUTTER HOOK OLD TYPE

P-PHP-ST





Nominal dimension	Material	EAN product number	Packaging in pcs		Price with VAT [€/pcs]
					
250/480	25/5	032874	10	1 000	2,22
333/510 *	30/5	049049	10	1 500	2,58
333/550	30/5	032881	10	1 000	2,52
333/610 *	30/5	032898	10	1 000	3,24

* Custom production

ON-ROOF GUTTER HOOK WITH SUPPORT



P-PHSSN



Nominal dimension	Material	EAN product number	Packaging in pcs		Price with VAT [€/pcs]
					
4	20/6	033444	25	1 000	6,12

GUTTER HOOK

P-PHP

Nominal dimension	Material	EAN product number	Packaging in pcs		Price with VAT [€/pcs]
					
200/380	25/4	032904	10	1 000	1,92
250/380 *	25/5	032911	10	1 000	1,98
250/430 *	25/4	033420	10	2 000	2,10
250/430	25/5	032928	10	1 000	2,04
250/480	25/5	032935	10	1 000	2,22
280/430 *	25/5	032942	10	2 000	2,10
280/430 *	30/5	032959	10	2 000	2,34
280/480	25/5	032966	10	2 000	2,22
280/480 *	30/4	032973	10	1 500	2,34
280/480	30/5	032980	10	1 000	2,58
280/530	25/5	032997	10	1 000	2,46
280/530	30/5	033000	10	1 500	2,76
333/480 *	25/5	033017	10	2 000	2,22
333/480 *	30/4	080769	10	1 500	2,34
333/480 *	30/5	033024	10	2 000	2,58
333/510	25/5	033031	10	2 000	2,40
333/510 *	30/4	033048	10	1 500	2,40
333/510 *	30/5	033055	10	1 500	2,58
333/550	25/5	033062	10	2 000	2,46
333/550 *	30/4	033079	10	1 500	2,52
333/550	30/5	033086	10	1 500	2,52
333/610	25/5	033093	10	1 000	2,76
333/610	30/5	033109	10	1 000	3,24
400/610 *	30/5	033437	10	1 000	3,54
400/610	30/6	033116	10	1 000	3,96
400/650	30/6	033123	10	1 000	4,20

* Custom production



GALVANIZED STEEL

HOOK FASCIA

P-PHPK



Nominal dimension	Material	EAN product number	Packaging in pcs		Price with VAT [€/pcs]
200	25/4	065001	25	1 000	2,76
250	25/4	065018	25	1 000	2,58
280	25/4	065025	25	1 000	2,70
333	25/5	065032	25	1 000	2,82
400	30/5	065049	20	800	4,44

GUTTER HOOK FASCIA WITH A NOSE

P-PHPNK



Nominal dimension	Material	EAN product number	Packaging in pcs		Price with VAT [€/pcs]
250	25/4	095282	25	1 000	3,72
280	25/4	095299	25	1 000	3,78
333	25/5	095305	25	1 000	3,84

GUTTER HOOK WITH A NOSE

P-PHPN



Nominal dimension	Material	EAN product number	Packaging in pcs		Price with VAT [€/pcs]
250/430	25/5	095787	10	1 000	2,34
280/480	25/5	095794	10	1 000	2,64
333/550	25/5	095800	10	1 000	2,88
400/610	30/5	095817	10	1 000	4,56

GALVANIZED STEEL

NATUR

CORNER OUTER

P-PRA



Nominal dimension	EAN product number	Packaging in pcs		Price with VAT [€/pcs]
200	000613	5	150	9,48
250	000620	5	150	7,68
280	000637	5	150	7,80
333	000644	5	150	8,04
400	000651	5	150	30,00

CORNER INNER

P-PRI



Nominal dimension	EAN product number	Packaging in pcs		Price with VAT [€/pcs]
200	000668	5	150	9,48
250	000675	5	150	7,68
280	000682	5	150	7,80
333	000699	5	150	8,04
400	000705	5	150	30,00

END CAP

P-PCL



Nominal dimension	EAN product number	Packaging in pcs		Price with VAT [€/pcs]
200	001566	6/60	1 440	0,59
250	001573	50	4 500	0,48
280	001580	50	4 500	0,54
333	001597	50	4 500	0,59
400	001603	4/40	960	1,44

END CAP WITH RUBBER SEAL

P-PCLG



Nominal dimension	EAN product number	Packaging in pcs		Price with VAT [€/pcs]
250	004000	25	2 250	1,08
280	004017	25	2 250	1,32
333	004024	25	2 250	1,44

OUTLET

P-PKL



Nominal dimension	EAN product number	Packaging in pcs		Price with VAT [€/pcs]
200/60	003263	20	600	5,94
250/60	003270	20	600	7,14
250/80	003287	20	600	4,32
280/80	003294	20	600	4,92
280/100	003300	20	600	5,10
333/80	003317	20	600	5,64
333/100	003324	20	600	5,34
333/120	003331	15	300	6,36
400/100	003348	15	300	10,68
400/120	003355	15	300	10,80
400/150	003362	15	300	11,40

GALVANIZED STEEL

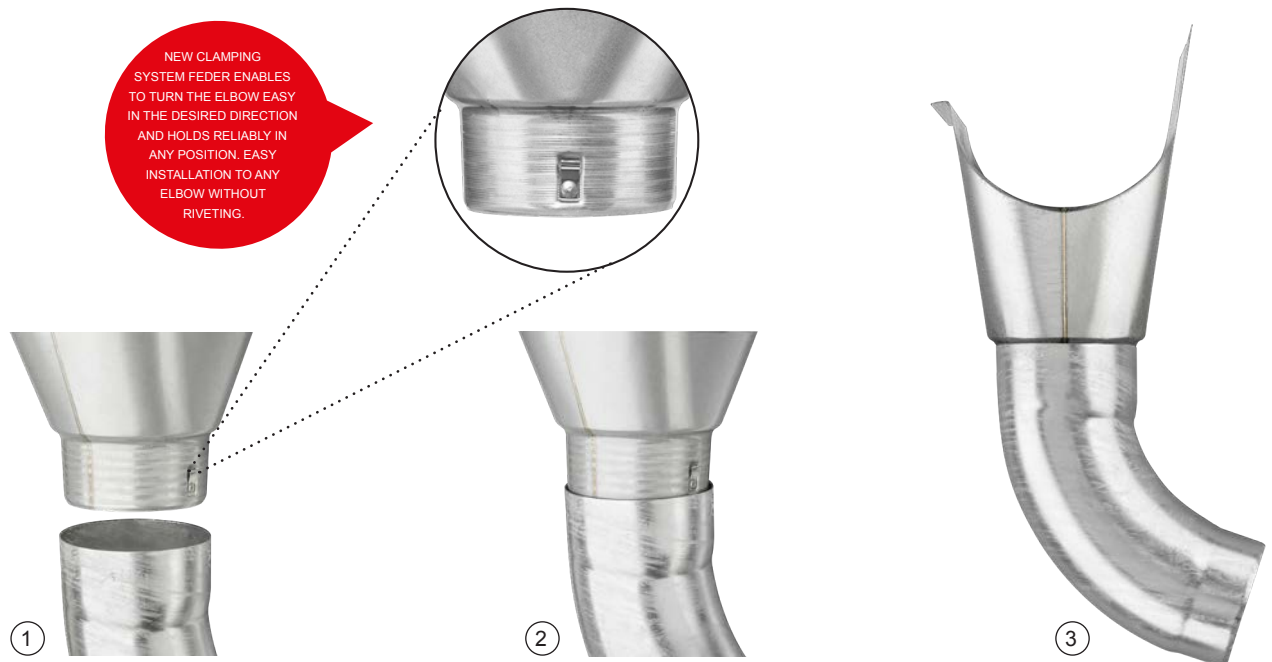

GALVANIZED STEEL

NATUR

GUTTER OUTLET NECK

P-PHRD/USS



Nominal dimension	EAN product number	Packaging in pcs		Price with VAT [€/pcs]
80	065650	25	1 000	1,26
100	065667	25	1 000	1,32
120	065674	15	750	1,62

LEAF SIEVE

P-PZN



Nominal dimension	EAN product number	Packaging in pcs		Price with VAT [€/pcs]
60	001047	30	2 160	3,36
80	001054	20	1 440	3,30
100	001061	15	1 080	3,36
120	001078	10	720	4,32
150	001085	5	360	7,20



GALVANIZED STEEL

GALVANIZED STEEL

NATUR

HOPPER DESIGN

P-PKLZ DE



Nominal dimension	EAN product number	Packaging in pcs		Price with VAT [€/pcs]
80	007681	2	36	54,00
100	007704	2	36	54,00
120	007728	2	36	55,20

HOPPER DESIGN ECCENTRIC

P-PKLZ DX



Nominal dimension	EAN product number	Packaging in pcs		Price with VAT [€/pcs]
80	007742	2	36	70,20
100	007773	2	36	70,20
120	007803	2	36	71,40

HOPPER CUBIC

P-PKLZ KU

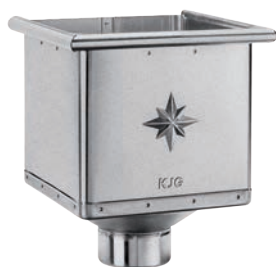

Nominal dimension	EAN product number	Packaging in pcs		Price with VAT [€/pcs]
80	007698	2	36	92,40
100	007711	2	36	92,40
120	007735	2	36	93,60

HOPPER CUBIC ECCENTRIC

P-PKLZ KX



Nominal dimension	EAN product number	Packaging in pcs		Price with VAT [€/pcs]
80	007759	2	36	92,40
100	007780	2	36	92,40
120	007810	2	36	93,60

HOPPER CUBIC ECCENTRIC WITH OVERFLOW PIPE

P-PKLZ KXV





Nominal dimension	EAN product number	Packaging in pcs		Price with VAT [€/pcs]
80	007766	2	36	123,60
100	007797	2	36	123,60
120	007827	2	36	123,60

RUBBER SEAL FOR HOPPER

P-PKLZ T



Nominal dimension	EAN product number	Packaging in pcs		Price with VAT [€/pcs]
				
IC 70-85	077103	5	600	4,80
IC 100-110	077110	5	600	4,92
IC 110-125	077097	5	600	5,04
PS 70-85	077134	5	600	5,40
PS 100-110	077141	5	600	5,88
PS 110-125	077127	5	600	6,00

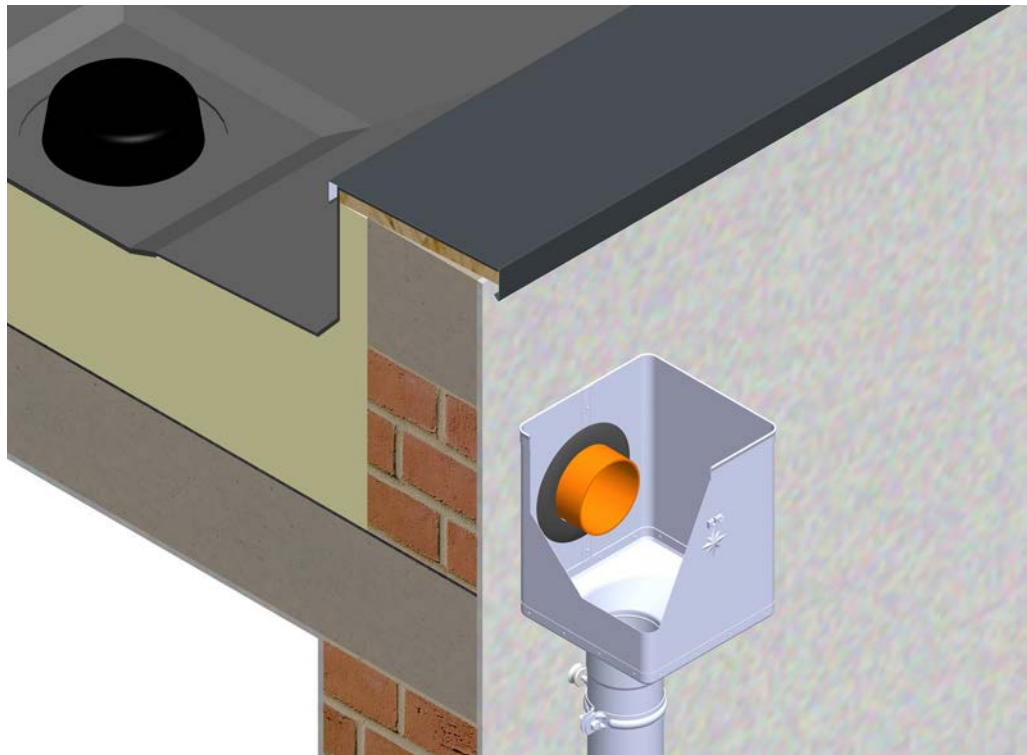

ELBOW 72°

P-PKZS



Nominal dimension	EAN product number	Packaging in pcs		Price with VAT [€/pcs]
60	034236	25	600	3,78
80	034243	25	400	3,72
100	034267	25	300	4,14
120	034281	15	180	5,64
150	033581	5	90	13,20

ELBOW RADIUS 85°

P-PKRZS



Nominal dimension	EAN product number	Packaging in pcs		Price with VAT [€/pcs]
80	034250	25	400	4,08
100	034274	25	300	4,68
120	034298	15	180	6,84

ELBOW BLIND 40°

P-PKTZS



Nominal dimension	EAN product number	Packaging in pcs		Price with VAT [€/pcs]
80	034359	25	400	3,84
100	034366	25	300	4,02
120	034373	15	240	7,08

GALVANIZED STEEL

NATUR

ELBOW FOLDED 72°

P-PKF2



Nominal dimension	EAN product number	Packaging in pcs		Price with VAT [€/pcs]
60	071729	10	3 000	2,58
80	071736	10	1 680	2,28
100	071750	10	1 000	2,64
120	071767	8	576	4,44

ELBOW FOLDED 85°

P-PKF3



Nominal dimension	EAN product number	Packaging in pcs		Price with VAT [€/pcs]
80	071743	10	1 680	2,88
100	071774	10	1 000	3,48

DOWNSPOUT ELBOW SOLDERED 72°

P-PKCV/USS



Nominal dimension	EAN product number	Packaging in pcs		Price with VAT [€/pcs]
80	095626	12	192	7,56
100	095633	20	180	8,04
120	095640	12	108	10,20

UPPER S-ELBOW SOLDERED 72°

P-PKCS/USS





Nominal dimension	EAN product number	Packaging in pcs		Price with VAT [€/pcs]
80	095596	6	96	9,42
100	095602	8	72	10,26
120	095619	6	54	12,72

DOWNPIPE [s=0,55]

P-PZR



Nominal dimension	Lenght in m	EAN product number	Packaging in m		Price with VAT [€/m]
					
60	2,0	005687	10	490	4,74
60	3,0	005694	15	735	4,74
80	1,0	005717	10	100	4,50
80	2,0	005731	10	250	4,50
80	3,0	005755	15	375	4,32
80	4,0	005779	20	500	4,32
100	1,0	005793	10	70	4,80
100	2,0	005816	10	160	4,80
100	3,0	005830	15	240	4,68
100	4,0	005854	20	320	4,68
100	5,0	005878	5	400	4,68
100 *	6,0	005885	6	480	4,68
120	1,0	005908	8	48	6,48
120	2,0	005922	10	120	6,48
120	3,0	005946	15	180	6,36
120	4,0	005960	20	240	6,36
120	5,0	005977	5	300	6,36
120 *	6,0	005984	6	360	6,36
150	3,0	006011	3	84	11,04
150	4,0	006028	4	112	11,04

* Custom production

GALVANIZED STEEL NATUR

DOWNPIPE [s=0,50]

P-PZR

Nominal dimension	Lenght in m	EAN product number	Packaging in m		Price with VAT [€/m]
80 *	1,0	005700	10	100	4,02
80 *	2,0	005724	10	250	4,02
80 *	3,0	005748	15	375	3,90
80 *	4,0	005762	20	500	3,90
100 *	1,0	005786	10	70	4,44
100 *	2,0	005809	10	160	4,44
100 *	3,0	005823	15	240	4,32
100 *	4,0	005847	20	320	4,32
100 *	5,0	005861	5	400	4,32
120 *	1,0	005892	8	48	5,82
120 *	2,0	005915	10	120	5,82
120 *	3,0	005939	15	180	5,64
120 *	4,0	005953	20	240	5,64

* Custom production



DOWNPIPE [s=0,45]

P-PZR

Nominal dimension	Lenght in m	EAN product number	Packaging in m		Price with VAT [€/m]
80 *	3,0	097965	15	375	3,48
100 *	3,0	097972	15	240	4,20
100 *	4,0	097989	20	320	4,20
120 *	3,0	097996	15	180	5,04

* Custom production



PLASTIC DOWNPIPE SLEEVE

SD-ZR FOLIA KJG

Nominal dimension	Lenght in m	EAN product number	Packaging in m		Price with VAT [€/m]
60-150	100,0	139726	100	6 000	0,46





GALVANIZED STEEL

NATUR

DOWNPIPE CONNECTOR

P-PSRU





Nominal dimension	EAN product number	Packaging in pcs		Price with VAT [€/pcs]
				
80	017253	10	900	3,96
100	017260	10	900	4,14
120	017277	8	720	4,44

DOUBLE ELBOW

P-PKO





Nominal dimension	EAN product number	Packaging in pcs		Price with VAT [€/pcs]
				
80	033710	20	320	7,68
100	033727	20	240	8,28
120	033734	15	180	12,60

DOWNPIPE BRANCH 72°

P-PZO/USS





Nominal dimension	EAN product number	Packaging in pcs		Price with VAT [€/pcs]
				
80/80	001337	4	120	17,16
100/60	001344	4	120	17,40
100/80	001351	4	120	17,64
100/100	001368	4	120	17,64
120/80	001375	3	90	18,24
120/100	001382	3	90	18,24
120/120	001399	3	90	18,24
150/120 *	001405	2	36	23,52
150/150 *	001412	2	36	23,52

* Custom production

WATER DISTRIBUTORS

P-PRV



Nominal dimension	EAN product number	Packaging in pcs		Price with VAT [€/pcs]
				
80 *	088086	1	–	201,60
100	088093	1	–	204,00
120	088109	1	–	270,00

* Custom production

GALVANIZED STEEL NATUR

DOWNPIPE BRACKET WITH PIN 150 mm

P-PO



Nominal dimension	EAN product number	Packaging in pcs		Price with VAT [€/pcs]
80	001719	25	1 000	2,10
100	001726	25	1 000	2,16
120	001733	25	1 000	2,34

DOWNPIPE BRACKET WITH PIN 200 mm

P-POD



Nominal dimension	EAN product number	Packaging in pcs		Price with VAT [€/pcs]
80	001740	25	1 000	2,28
100	001757	25	1 000	2,34
120	001764	25	1 000	2,46

DOWNPIPE BRACKET WITH PIN 300 mm

P-PODD



Nominal dimension	EAN product number	Packaging in pcs		Price with VAT [€/pcs]
80	001771	20	800	2,52
100	001788	20	800	2,58
120	001795	20	800	2,76

PIPE BRACKET WITH THREAD M10

P-POB



Nominal dimension	EAN product number	Packaging in pcs		Price with VAT [€/pcs]
60	002167	25	3 000	2,16
80	002174	25	3 000	1,68
100	002181	25	3 000	1,74
120	002198	25	3 000	1,98
150	002204	20	2 400	3,54



GALVANIZED STEEL

NATUR

PIPE BRACKET WITH THREAD M8

P-POB





Nominal dimension	EAN product number	Packaging in pcs		Price with VAT [€/pcs]
				
60	073372	25	3 000	2,16
80	073389	25	3 000	1,68
100	073396	25	3 000	1,74
120	073402	25	3 000	1,98
150	073419	20	2 400	3,54

STAINLESS STEEL SCREW FOR DOWNPIPE BRACKET M6x20

P-POB-NSK





Nominal dimension	EAN product number	Packaging in pcs		Price with VAT [€/pcs]
				
M6 x 20 *	071675	1	–	0,18

* Custom production

SCREW FOR DOWNPIPE BRACKET WITH THREADED TORX M10

P-POB-HT





Nominal dimension	EAN product number	Packaging in pcs		Price with VAT [€/pcs]
				
80	002464	100	40 000	1,20
140	002471	100	28 000	1,50
200	002488	100	20 000	1,86
250	002495	100	16 000	2,04
300	002501	100	11 200	2,04

DOWEL M10

P-POB-HN DB





Nominal dimension	EAN product number	Packaging in pcs		Price with VAT [€/pcs]
				
120	002426	100	25 000	0,48

DOWEL WITH LAMELLA M10

P-POB-HN DB



Nominal dimension	EAN product number	Packaging in pcs		Price with VAT [€/pcs]
				
180	002433	100	12 000	0,50
240	002440	100	12 000	0,60
280	002457	100	12 000	0,64



GALVANIZED STEEL

NATUR

COMBISCREW TORX M10

P-POB-ZT/SZ





Nominal dimension	EAN product number	Packaging in pcs		Price with VAT [€/pcs]
				
140	002587	50	10 400	0,54
180	002594	50	10 400	0,66

DOWEL FOR DOWNPIPE BRACKET SQUARE PIM 7x7

P-POB-HN R1





Nominal dimension	EAN product number	Packaging in pcs		Price with VAT [€/pcs]
				
200/60	002600	250	15 000	0,20

INSULATION DOWEL M10



P-POB-HN IZOL



Nominal dimension	EAN product number	Packaging in pcs		Price with VAT [€/pcs]
				
M10 x 96	001207	25	2 625	3,24



INSULATING DOWEL TIP OF THE BRICK WITHOUT INSULATION P-POB-HN WDVS140 M10



Nominal dimension	EAN product number	Packaging in pcs		Price with VAT [€/pcs]
				
140	144843	1/5	750	5,76



INSULATING DOWEL TIP OF THE BRICK WITH INSULATION P-POB-HN WDVS300 M10



Nominal dimension	EAN product number	Packaging in pcs		Price with VAT [€/pcs]
				
300	144850	1/5	500	9,36

STAINLESS STEEL UNI PLATFORM TO ATTACH OB M10 P-POB-HN PLAT M10



Nominal dimension	EAN product number	Packaging in pcs		Price with VAT [€/pcs]
				
M10	144836	25/500	5 000	4,02

GALVANIZED STEEL

NATUR

THREADED ROD M10

P-POB-ZT



Nominal dimension	EAN product number	Packaging in pcs		Price with VAT [€/pcs]
60	002556	100	20 800	0,24
100	002563	100	15 600	0,36
150	002570	50	10 400	0,66

DOWNPIPE BRACKET MOUNTING PLATE M10

P-POB-ZT MP



Nominal dimension	EAN product number	Packaging in pcs		Price with VAT [€/pcs]
80 x 30	002518	25	5 200	1,38

SCREW FOR DOWNPIPE BRACKET WITH THREADED M8

P-POB-HB



Nominal dimension	EAN product number	Packaging in pcs		Price with VAT [€/pcs]
150	071590	100	5 000	0,78
200	071606	100	5 000	1,10
250	071613	100	5 000	1,26
300	071620	100	5 000	1,32

DOWEL M8











P-POB-HBN-SS



Nominal dimension	EAN product number	Packaging in pcs		Price with VAT [€/pcs]
150	071637	100	5 000	0,30
200	071644	100	5 000	0,31
250	071651	100	5 000	0,42
300	071668	100	8 000	0,44

RUBBER CAP FOR DOWNPIPE BRACKET SCREW

P-POB-HT AKG

Nominal dimension	EAN product number	Packaging in pcs		Price with VAT [€/pcs]
				
 29 x 13	002280	50	16 800	0,30
 29 x 13	002211	50	16 800	0,30
 29 x 13	002235	50	16 800	0,30
 29 x 13	002266	50	16 800	0,30
 29 x 13	002242	50	16 800	0,30
 29 x 13	002228	50	16 800	0,30
 29 x 13	002273	50	16 800	0,30
 29 x 13	002259	50	16 800	0,30
 29 x 13	002297	50	16 800	0,30



GALVANIZED STEEL

NATUR



DOWNPIPE FLAP

P-PZV/USS

Nominal dimension	EAN product number	Packaging in pcs		Price with VAT [€/pcs]
80	034380	6	180	8,76
100	034397	5	150	9,78
120	034403	3	90	13,86



DOWNPIPE FLAP WITH SIEVE

P-PZVS/USS

Nominal dimension	EAN product number	Packaging in pcs		Price with VAT [€/pcs]
80	006035	6	180	11,28
100	006042	5	150	12,54
120	006059	3	90	20,04



ALUMINIUM WATER COLLECTOR+HOSE

W-WZVHA

Nominal dimension	EAN product number	Packaging in pcs		Price with VAT [€/pcs]
80	001481	1	60	70,20
100	001498	1	60	64,80
120	001504	1	60	135,00

Dimension: 80, 120

Dimension: 100

GALVANIZED STEEL

NATUR



PROTEC.GUTTER PIPE COL.

P-POZR

Nominal dimension	Lenght in m	EAN product number	Packaging in pcs		Price with VAT [€/pcs]
80	1,0	009708	1	70	72,00
100	1,0	009715	1	60	54,00
100	1,5	009722	1	60	106,80



PROTEC.GUTTER PIPE COL.

P-POZR

Nominal dimension	Lenght in m	EAN product number	Packaging in pcs		Price with VAT [€/pcs]
120	1,0	009739	1	40	126,00
120	1,5	009746	1	40	171,60



PIPE CLAMP WITH GASKET M10

P-POB-OZR

Nominal dimension	EAN product number	Packaging in pcs		Price with VAT [€/pcs]
80	002525	25	1 250	1,86
100	002532	25	1 250	2,40
120	002549	20	1 000	2,70

GALVANIZED STEEL NATUR

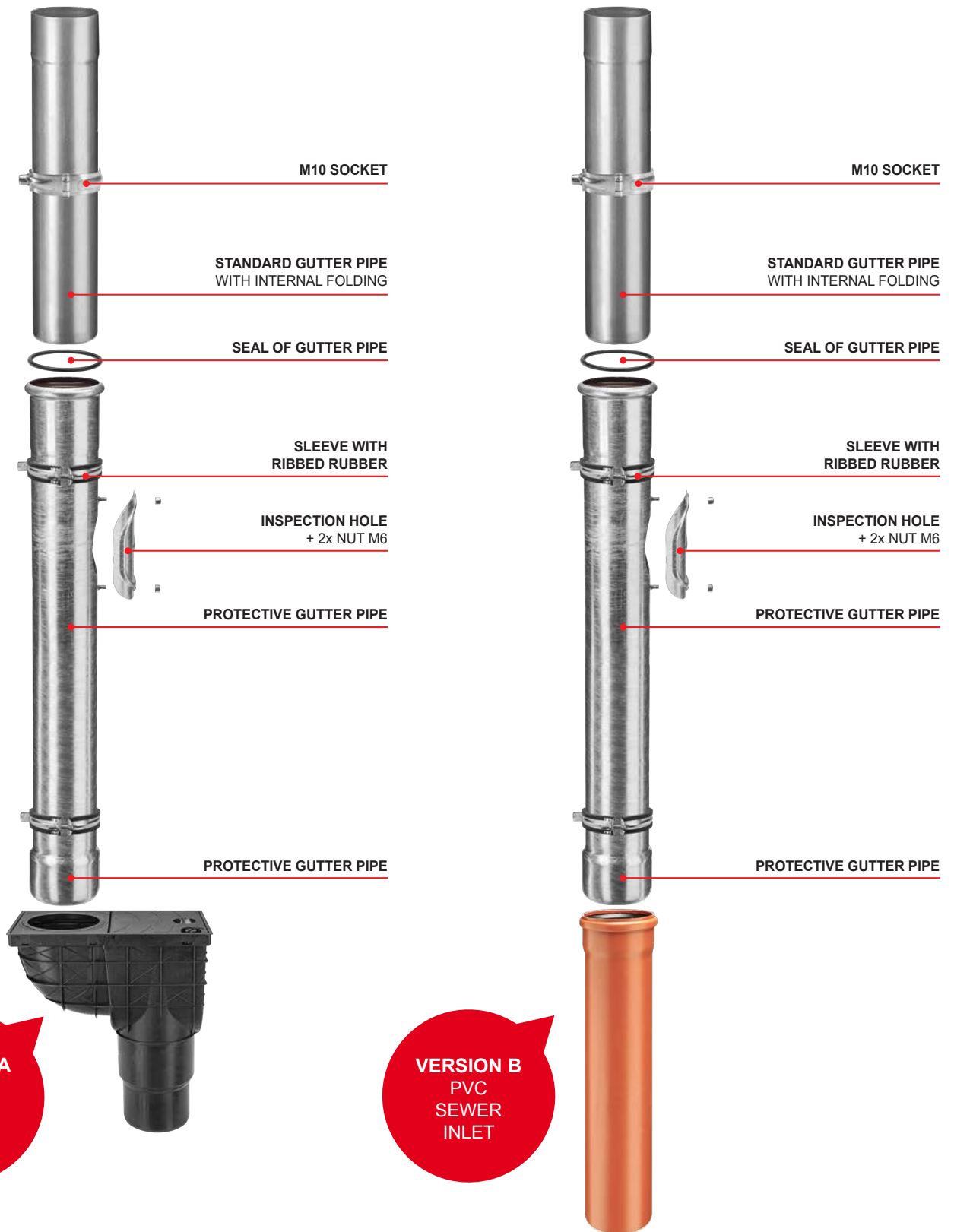

I. BASIC PROVISIONS

- The company KJG a.s., with its registered office at Malinovského 800/131, 916 21 Čachtice, Company ID: 31 439 951 (hereinafter referred to as the „Seller“), issues the following General business terms and conditions that apply to the sale and supply of gutter roof system with accessories, light roofing, trapezoids, metallurgical materials, roofing accessories, tools, machinery and commercial goods related to the roof system (hereinafter referred to as the „goods“) performed by the Seller on the basis of a framework purchase contract (referred to as „FPC“) in relation to an entrepreneur in carrying out its business activities and to the state, state organization, self-governing territorial unit or to a legal entity established by law as a public institution in the provision of public needs or its own operation (hereinafter referred to as the „Buyer“).
- These General terms and conditions as an integrated part of FPC are an integral part of each individual purchase contract (hereinafter also „IPC“ or „contract“) concluded between the Seller and the Buyer on the basis of FPC.

II. CONCLUSION OF PURCHASE CONTRACT

- The Buyer's written order is considered to be a proposal to conclude an IPC, whereby each Buyer's order should contain:
 - identification data of the Buyer necessary for issuing the invoice,
 - specification of the ordered goods (especially type, kind, quantity and dimensions),
 - delivery place, delivery time and method of delivery of goods,
 - date of issue of the order,
 - name, surname, position and signature of the person authorized to act on behalf of the Buyer.
- The IPC is considered closed at the moment of written confirmation of the Buyer's order by the Seller.

III. PURCHASE PRICE AND PAYMENT TERMS

- The Buyer undertakes to pay the Seller the purchase price for the ordered goods properly and in due time. The purchase price is determined according to the Seller's price list (prices of goods are to be understood without VAT) valid on the day of submitting the order by the Buyer and its amount will be stated by the Seller in the Buyer's order confirmation including VAT (when delivering goods in Slovakia) according to valid legal regulations. In necessary cases, if the purchase price is determined on the basis of individual price calculation based on the valid price list, the Buyer shall be obliged to pay the purchase price up to the amount determined by price calculation on condition that the Seller shall determine the final purchase price according to costs incurred, but this shall not exceed the purchase price determined by calculation. The buyer is entitled to a discount on the price of the goods in the amount resulting from the FPC; if the Seller changes the amount of the Buyer's discount on the price of the goods during the FPC period, it shall immediately inform the Buyer in writing. When delivering the goods in the Slovak Republic, the Seller charges the Buyer, in addition to the price of the goods, VAT in accordance with the valid legal regulations.
- The Buyer shall have a set financial credit limit for the purchase of goods and the maturity of invoices in accordance with the FPC, while the Seller shall be entitled to invoice the purchase price to the Buyer on the day of delivery or shipping the goods to the Buyer, respectively. After overdrawing the credit limit specified in the FPC or in the case of non-payment of the invoice by the Buyer within the due date, the Seller is entitled to interrupt the delivery of goods to the Buyer on the basis of the contract and not to confirm another written order of the Buyer. The Seller shall continue with further deliveries of goods:
 - in the case of exceeded credit limit - after payment of the oldest invoices up to the amount of exceeding the credit limit and simultaneous payment of the value of the required purchase of goods,
 - in the case of non-payment of the invoice within the due date - after its full payment. The Seller shall be entitled to change the credit limit set for the Buyer at any time throughout the duration of the FPC.
- Payment shall be deemed to have been made in time if it has been credited to the Seller's account or paid in cash at the Seller's cash desk by the due date.
- If the Buyer does not pay the invoice within the due date, the Seller shall be entitled to charge the Buyer for interest on late payment in the amount of 0.05 % of the unpaid amount for each day of delay.

IV. DELIVERY OF GOODS AND RETENTION OF TITLE

- The Seller shall be obliged to deliver the goods to the Buyer in the quantity agreed in the contract and in a quality and design that is suitable for the purpose for which the goods are used. The Buyer is obliged to take over the goods delivered by the Seller.
- Unless the contracting parties have agreed otherwise, the Seller is obliged to pack or arrange the goods for transport in the manner that is usual for such goods in business.
- Delivery of the goods shall take place within the period and in the manner agreed by the contracting parties in the contract.
- Upon delivery of the goods by the Seller, the Buyer's employee shall be obliged to prove the right to take over the goods.
- If the goods are to be made available not loaded on a means of transport at the Seller's registered office (or the relevant warehouse of the Seller, to which the Buyer has submitted an order) by the Buyer to the designated carrier, the latter is obliged to prove the right to take over the goods.
- In the event that the goods are to be delivered to the Buyer to the delivery point specified in the order using a Seller's vehicle, the Seller will charge the Buyer for transport costs according to the transport price list valid on the day of submitting the order by the Buyer. At the same time, the Seller reserves the right to unload the goods only in an available terrain at its sole discretion.
- In the case of goods to be sent to the Buyer, the Seller shall charge the Buyer for postage, unless agreed otherwise.
- The Buyer undertakes to withdraw the goods within the delivery period. If the Buyer fails to fulfil its obligation to take over the goods within the delivery period, the Seller shall invite the Buyer to fulfil the Seller's obligation within an additional reasonable period. Failure to take over the goods by the Buyer nor within an additional reasonable period gives rise to the Seller's right to withdraw from the contract.
- The buyer who does not pay the whole amount of the purchase price until the delivery of the goods will acquire ownership of the delivered goods only after full payment of the purchase price.

V. PASSING OF RISK OF DAMAGE TO GOODS

- The risk of damage to the goods passes to the Buyer at the moment the Buyer takes over the goods from the Seller, or by the carrier designated by him, or if the Buyer fails to do so in time, at the time when the Seller or the Seller's designated carrier allows the Buyer to dispose of the goods, while the Buyer is being aware of this possibility and breaches the contract by not taking over the goods.
- If the Seller is to hand over the goods for transport by the carrier designated by the Buyer at its registered office in Čachtice (or the relevant warehouse of the Seller) from which the Buyer is to take over the goods, the risk of damage to the goods passes to the Buyer upon handing over the goods to this carrier.
- In the event that the Seller is to send the goods to the Buyer, the risk of damage to the goods passes to the Buyer at the time of delivery of the goods to the first carrier for transport to the destination.
- The buyer is obliged to inspect the goods without undue delay after the risk of damage to the goods has passed. If the goods are sent to the Buyer, the Buyer is obliged to inspect the goods without undue delay after their delivery to the destination. The company KJG a.s. reserves the right to change prices, packaging and printing.

VI. LIABILITY FOR DEFECTS AND WARRANTY

- The Seller shall be responsible for the defect by which the goods have been affected at the moment when the risk of damage to the goods passes to the Buyer, even if the defect becomes apparent only after this time. The Seller is also responsible for any defect arising after the risk of damage to the goods has passed to the Buyer if caused by a breach of the Buyer's duties.
- If the Buyer does not inspect the goods or does not arrange to inspect them at the time of passing the risk of damage to the goods, the Buyer may claim for defects detectable during this inspection only if the Buyer proves that the goods were already affected by these defects at the time of passing the risk of damage to the goods.
- The Buyer shall be obliged to notify the Seller of defects in the goods without undue delay after:
 - The Buyer found the defects,
 - The Buyer, while exercising professional care, should have found defects during the inspection, which the Buyer is obliged to carry out after the risk of damage to the goods has passed, or
 - The defects could be found later with the exercise of professional care, but no later than within two years from the time of delivery of the goods, or from the arrival of the goods to the destination specified in the contract. For defects covered by the quality warranty, instead of this period of time the warranty period applies.
- If the Seller provides the Buyer with a warranty for the quality of the delivered goods, it shall do so by making a statement in a separate warranty card, which will also state the procedure for complaints.
- The warranty period begins to run from the date of delivery of the goods. If the Seller is obliged to send the goods, the warranty period runs from the day the goods arrive at its destination. The warranty period does not run for a period during which the Buyer cannot use the goods due to their defects, which is the Seller's responsibility.
- In the case of delivery of goods to the Buyer with defects, the use of prov. § 436, § 437, § 439 par. 2, 3, 4 and § 441 of the Commercial Code are explicitly excluded and the Seller in such a case shall provide the Buyer with a discount on the purchase price or shall remove the defects in the goods complained by the Buyer:
 - by delivery of missing goods,
 - by repair of goods or delivery of replacement goods in case of remediable defects
 - by delivery of replacement goods in the event of irreparable defects.
- The discount granted by the Seller on the purchase price shall correspond to the difference between the value of the goods without defects and the value of the goods delivered with defects, while the decisive time for determining the values is the time at which proper fulfillment should have taken place. The Buyer, to whom the Seller has been granted a discount on the purchase price, is not entitled to claim compensation for the loss of profit due to the lack of properties of the goods to which the discount applies.
- Upon delivery of replacement goods, the Seller shall be entitled to demand the exchanged goods to be returned to the Seller at the Buyer's expense in the condition in which they were delivered to the Buyer. This does not apply if the impossibility of returning the goods in the condition specified therein is not caused by the actions or omissions of the Buyer, or if the change in the condition of the goods occurred as a result of an inspection duly performed to detect defects in the goods. In the event that before the detection of defects the Buyer sold the goods or part thereof or consumed the goods in whole or in part or altered them in their normal use, the Buyer shall be obliged to return unsold or unconsumed goods or altered goods and provide the Seller with compensation to the extent to which the Seller has benefited from that use of the goods.
- The Seller's responsibility for defects not covered by the quality warranty does not arise if these defects were caused after the passing of the risk of damage to the goods by external events and were not caused by the Seller or the persons who helped to fulfil the Seller's obligation.

VII. VIS MAJOR

- If, after the conclusion of the contract, unforeseeable and uncontrollable circumstances arise which create a permanent or temporary obstacle to the fulfillment of the obligations of the contracting parties of the concluded contract (refer to vis major), the non-fulfillment of obligations (in case of permanent obstacle) by a contracting party, or a delayed fulfillment of obligations (in case of temporary obstacle), shall not be considered a breach of this contract and the contracting party shall not be responsible for any damages that arise in connection with non-fulfillment of contractual obligations. If the obstacle incurred is only temporary for the fulfillment of obligations under the contract, the contracting parties undertake to start fulfilling their contractual obligations immediately after this obstacle disappears. Each contracting party shall be obliged to inform immediately the other contracting party of the occurrence of the above obstacles.
- The followings are mainly considered to be vis major: natural events, arbitrary acts of third parties, strikes, work lockouts, blockades, wars (declared or undeclared), a change in the political situation or any other similar event which precludes or unduly impedes the exercise of rights and obligations under the contract.

VIII. PRIVACY POLICY

- The Buyer (for the purposes of this article also another person signed on the FPC and the order on behalf of the Buyer) expressly grants to the Seller, according to Act no. 428/2002 Coll. on personal data protection as amended (hereinafter referred to as the „Act“), consent to the processing of its personal data specified in the FPC and the Buyer's order.
- The Buyer expressly authorizes the Seller to process personal data for the purposes of:
 - exercise of the rights and obligations arising from the FPC and IPC,
 - keeping records, the obligation of which arises for the Seller by law or on the basis of the Act,
 - performing marketing activities.
- The Buyer expressly gives the Seller consent to provide the Buyer's personal data for the purposes stated in point 8.2 to a third party which has been entrusted by the Buyer with the activity in question.
- The Buyer expressly grants the Seller consent to the processing of personal data:
 - for the period in which the Seller is obliged to keep the records referred to in point 8.2. b /,
 - for the period in which it is necessary to protect the legal rights and legally protected interests of the Seller.
- The Buyer takes into account that it has the right to revoke its consent to the processing of personal data and require the liquidation of its personal data in the event that the Seller, or a third party to whom the Seller has provided personal data, respectively, breaches the obligations arising from the Act.

IX. FINAL PROVISIONS

- The Buyer is not entitled to transfer or assign the rights resulting for the Buyer from the FPC or IPC to a third party without the express consent of the Seller.
- The FPC may be amended, unless otherwise provided in these General Terms and Conditions, only in the form of written amendments signed by representatives of both the contracting parties.
- The agreed deviating provisions in the IPC between the Seller and the Buyer take precedence over the provisions of the FPC and these General Terms and Conditions. Legal relations that are not regulated in the FPC, IPC or in these General Terms and Conditions are governed by the Commercial Code and other generally binding legal regulations in force in the Slovak Republic, excluding the use of conflicting rules of law and the application of the UN Convention on Contracts for the International Sale of Goods /CISG/ of April 11, 1980 and their possible amendments in the case the Buyer has its registered office (place of business) in another state or the goods are delivered to another state.
- All disputes arising from the implementation of the content of the FPC will be resolved by the contracting parties through an amicable settlement. Disputes that cannot be resolved by mutual agreement are entitled to be resolved (exclusively) by the competent court in the Slovak Republic.
- These General Terms and Conditions are issued by the Seller pursuant to § 273 of the Commercial Code, with effect from January 1, 2017.